



DEALER PRODUCT GUIDE



BlueDiamondAttachments.com



4512 ANDERSON ROAD, KNOXVILLE TN 37918 | 888-376-7027



ABOUT BLUE DIAMOND® ATTACHMENTS

Blue Diamond® Attachments is a trusted and reliable company. Established in 1995, Blue Diamond® is a widely recognized name in the global attachments industry. We are committed to unparalleled customer service from the very first call to the follow-up and service.

In today's fast-paced environment, delivering quickly and on time are key to success. Blue Diamond® Attachments stocks thousands of finished products in our warehouses ready to ship. This results in a big advantage for our customers with many shipments leaving in 2–3 days. Our Tennessee facilities alone are over 250,000-square-foot situated on 32 acres. These facilities, along with streamlined processes, allow most of our orders to leave our facility within 10 days. Our parts department keeps thousands of replacement parts at the ready and strives to ship all parts orders received before noon the same day the order is placed! Tracking numbers are sent to our customer the day after the shipment leaves our dock.

We are located in Knoxville, Tennessee. This central location allows our products to reach more than half of the United States population within 2–3 days' shipping time. Our numerous loading docks allow us to load several trailers at once to ensure orders are shipped quickly. In addition, we are the only 1-day point of export to multiple foreign ports.



PARTS & ACCESSORIES WAREHOUSE

Whether you have one attachment or maintain an entire fleet, having quick access to the right parts **24/7** can make the difference in keeping your attachments working properly and staying profitable or losing significant profit from downtime. When you buy genuine Blue Diamond® parts, you are buying top-quality parts and getting expert advice and assistance from our product support team.



Whether you buy parts online or through visiting your closest Blue Diamond dealer, buy with trust, buy with confidence and, buy knowing that we will take care of you and your attachment – the first time and every time.

ONLINE PARTS STORE

- Parts orders received before noon EST ship the same day
- Dealer-specific registration form
- Net 30-day terms available when qualified
- **24/7** ordering
- Confirm parts visually when ordering

BDAParts.com



DEALER FLOOR PLAN FINANCING AVAILABLE

We are excited to offer a dealer floor plan financing program through *Northpoint Commercial Finance*, featuring:

- No dealer setup fees
- 60 Day, 90 Day, or 180 Day interest-free financing

This opportunity is subject to credit approval and minimum annual commitment. Please contact a sales representative for more details.

RENTAL RECOMMENDED ATTACHMENTS

More than 20 years of service in the rental industry has influenced the way we build attachments. The Rental Recommended seal helps guide our customers to attachment models that are best suited for rental use. Attachments marked with this seal are recommended for rental for any of these reasons:

- Heavy construction resists damage
- Hose routing keeps hoses out of harm's way
- Versatile, attaches to a variety of machines
- Easy to use, minimal training is required



While these select Blue Diamond® products are recommended for rental use, any of our products may be used for rental application with careful consideration. Please contact our sales representatives with any questions.



MAKING A DIFFERENCE THROUGH COMMUNITY ASSISTANCE

Blue Diamond® Attachments founded the BD Assist program in 2016 to help communities in need of aid due to disasters and other related situations. Blue Diamond® created a fleet of equipment and attachments that is donated to help victims of such unfortunate circumstances. This is a way we can provide assistance with cleanup and restoration efforts while giving back to the communities that support our business. If you are a non-profit organization or government agency with a need for this funded equipment program, please reach out to us to see if we have a unit available in your area (*U.S. only*).



WHO

Non-profit organizations or government agencies for communities in need of aid due to disasters and other related situations.



WHAT

A fleet of equipments for community assistance to assist with clean-up and restoration efforts.



HOW

Fill out an application on BlueDiamondAssist.com. Let us help you with your needs today!

BD ASSIST MISSIONS

GATLINBURG, TN WILDFIRE

Sadly, the fires in November 2016 claimed the lives of 14 residents, destroyed 2,500 structures, and caused millions of dollars' worth of destruction to homes, residences, and the beautiful Smoky Mountain National Park. This is exactly what the BD Assist program was designed for! In the pictures

below, you can see the machine in action at the street department headquarters in the city of Gatlinburg, assisting in cleanup.



COOKEVILLE/LEBANON, TN TORNADO

In March 2020, three tornadoes hit Putnam County. One EF4 tornado hit the Cookeville and Lebanon area killing 18 people.

The destruction stretched 50 miles across 4 counties.

The BD Assist team members contacted the local government

and volunteer organizations and delivered a BD Assist machine to one of the most damaged areas in Lebanon, Tennessee. The machine spent 4 months clearing debris in neighborhoods and local businesses.



HOUSTON, TX HURRICANE HARVEY CLEANUP

In August 2017, Hurricane Harvey's massive damage left a substantial amount of cleanup to do. The BD Assist machine spent many months working in the Houston and Port Aransas areas assisting in removal of the endless amounts of debris.

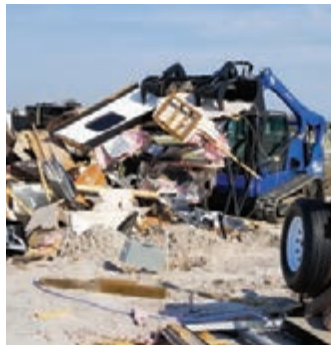

SHINING LIGHT, KNOXVILLE, TN EQUESTRIAN CLEANUP

Having lost their previous rental land, BD Assist offered to donate a machine and land clearing attachments to the cause in May 2021. With 45 acres still to clear, we were proud to be involved!



CHATTANOOGA, TN TORNADO

On April 2020, an EF3 tornado touched down overnight in three counties near Chattanooga, TN, causing widespread damage and killing 3 people. The tornado path

was approximately 9 miles long and 1,500 yards wide. The BD Assist team partnered with Bobcat of Chattanooga to assist in the removal of debris and clean up in these devastated counties.



The BD Assist team partnered with Bobcat of Chattanooga to assist in the removal of debris and clean up in these devastated counties.

NEWNAN, GA TORNADO

Newnan, GA. was struck by a tornado on March 2021 with damage at EF4 levels or greater. Wind speeds up to 170 mph carved a path of devastation, removing roofs, uprooting trees, and damaging

businesses. Blue Diamond® was able to send our skid steer with our root grapple attachment to help clear debris and fallen trees.



DAWSON SPRINGS, KY TORNADO

The BD Assist Excavator unit headed out to help the community in Dawson Springs, Kentucky. We

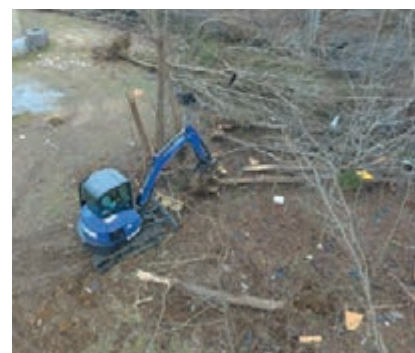

assisted with helping their community cleanup debris from the devastating December 2021 tornadoes.

BREMEN, KY TORNADO

Bremen, KY suffered significant damage in the December 2021 tornado. BD Assist was thrilled to contribute to their cleanup efforts with the loan of our excavator.



BOWLING GREEN, KY TORNADO

In December 2021, Eastwood Baptist Church coordinated and conducted a significant amount of cleanup in Bowling Green following the tornadoes. BD Assist was proud to support both the city of Bowling Green and Western Kentucky University with two of our units.



PONCHATOULA, LA HURRICANE IDA

In September 2021, Hurricane Ida left parts of Louisiana and Mississippi devastated in its wake with extensive damage and loss of life. BD Assist stepped in to lend our BD Assist machine and grapple bucket to help with cleanup efforts.



WAVERLY, TN FLOODING

In August 2021, Waverly experienced severe flood damage after 17 inches of rain fell within 24 hours. BD Assist provided equipment to help with the cleanup work which was received with much gratitude by Humphreys County.



MAYFIELD, KY TORNADO

One of our BD Assist skid steer with grapple units was loaned for several weeks to Hutson, Inc. in Mayfield, Kentucky to provide assistance in the cleanup at one of our valued dealers. This dealer lost their building and equipment nearly entirely to the December 2021 tornado.



NORTHWEST CHURCH OF GOD, KNOXVILLE, TN CLEANUP

In March 2022, BD Assist provided a skid steer and grapple bucket to Northwest Church of God in Tennessee to assist in their volunteer efforts in cleaning up private property that had become encamped by displaced people. With the help of the equipment, the volunteers filled a 20 cubic foot dumpster with garbage and cleared the land of a lot of undergrowth.



WINTERSET, IA TORNADO

Winterset, Iowa was struck by a deadly tornado killing 7 and damaging several homes on March 2022. As people banded together to help their neighbors in need, an energetic team of volunteers called GoServ Global reached out for a loan of equipment from Blue Diamond Assist. We were thrilled to deliver our newest skid steer and 2 attachments to the site within 48 hours!





SKID STEER ATTACHMENTS

3 POINT CONVERSION ADAPTER.....	10	FORK, NURSERY.....	35
AUGER ADAPTERS.....	10	FORK, PALLET.....	35-37
AUGER EXTENSION.....	11	GRAPPLE, BUCKET.....	38
AUGER BITS.....	11-12	GRAPPLE, BUCKET ROCK.....	39
AUGER DRIVE, EXTREME DUTY SERIES 2.....	13	GRAPPLE, RAKE.....	40
AUGER MOUNT, TELESCOPIC.....	13	GRAPPLE, ROOT.....	41-42
BACKHOE.....	14	HAY ACCUMULATOR.....	43
BALE SQUEEZE, HYDRAULIC ROUND.....	14	HAY SPEARS.....	43
BLADE, 6-WAY DOZER.....	15	LAND PLANE.....	44
BOX SCRAPER RIPPER.....	15	LOG GRAPPLE.....	44
BREAKER, HYDRAULIC.....	16	LOG SPLITTERS.....	45
BROOM, ANGLE SEVERE DUTY SERIES 2.....	17	MATERIAL ROLLER.....	45
BROOM, ANGLE HEAVY DUTY SERIES 2.....	18	MATERIAL SPREADER.....	46
BROOM, PICKUP SERIES 2.....	19	MOUNT PLATE.....	46
BROOM, PUSH, HEAVY STANDARD DUTY.....	19	POST DRIVER, VIBRATORY SERIES 2.....	47
BRUSH CUTTER, 84" DUAL SPINDLE.....	20	POWER RAKES.....	48-50
BRUSH CUTTER, HEAVY DUTY.....	20	RIPPER.....	50
BRUSH CUTTER, EXTREME DUTY (OPEN/CLOSED).....	21	ROAD SAW.....	51
BRUSH CUTTER, SWING ARM.....	21	ROCK AND CONCRETE GRINDER.....	51
BRUSH CUTTER, SEVERE DUTY SERIES 2 (OPEN).....	22	ROOF TRUSS JIB.....	52
BUCKET, 4-IN-1.....	23	ROOT RAKE, SEVERE DUTY.....	52
BUCKET, DISPENSING.....	23	ROTOTILLER.....	52
BUCKET, DUMPSTER.....	24	SILT FENCE INSTALLER.....	53
BUCKET, FRONT DUMP.....	24	SNOW BLADE, AUTOWING.....	54
BUCKET, ROCK, STANDARD EXTREME DUTY.....	24	SNOW BLADE, HD SERIES 2 MULTI-PURPOSE.....	54
BUCKET, GENERAL PURPOSE.....	25	SNOW BLADE, SD SERIES 2 MULTI-PURPOSE.....	55
BUCKET, LOW PROFILE, SEVERE DUTY.....	26	SNOW PLOW, V-BLADE.....	55
BUCKET, TURKEY LITTER, HEAVY DUTY.....	27	SNOW BLOWER, EXTREME DUTY.....	56
BUCKET, UTILITY.....	27	SNOW PUSHER, STANDARD/HEAVY DUTY.....	57
BUCKET, UTILITY, HIGH-CAPACITY.....	28	SOD ROLLER.....	58
BUCKET, UTILITY, HIGH-CAPACITY, HIGH-BACK.....	28	STUMP GRINDER.....	59
BUCKET, SCREENING.....	29	STUMP GRINDER, SWING ARM.....	59
BUCKET, SLAB.....	29	TRAILER SPOTTER.....	60
BUCKET, STUMP.....	29	TREE BOOM.....	60
BUCKET, SNOW & MULCH.....	29-30	TREE GRUBBER, EXTREME DUTY.....	60
COLD PLANER.....	31-32	TREE PULLER.....	61
DISC MULCHER.....	33	TREE SHEAR.....	61
DRUM MULCHER.....	33	TRENCHER.....	62-63
FORK, GRAPPLE, MAT SEVERE DUTY.....	34	VIBRATORY ROLLER.....	63



EXCAVATOR ATTACHMENTS

AUGER DRIVE, EXTREME DUTY, SERIES 2.....	64	BUCKET, SCREENING	70
BREAKER, HAMMER.....	65	LOG SPLITTER	70
BRUSH CUTTER, HEAVY DUTY, MINI	66	PLATE COMPACTOR	71
BRUSH CUTTER, SEVERE DUTY, MINI.....	66	RAKE	71
BRUSH CUTTER, SEVERE DUTY SERIES 2, MINI	67	ROCK AND CONCRETE GRINDER.....	72
BRUSH CUTTER, EXTREME DUTY	67	TREE GRUBBER.....	73
BRUSH CUTTER, SEVERE DUTY	68	VIBRATORY POST DRIVER, SERIES 2	73
BUCKET, HEAVY DUTY	69		



TRACTOR ATTACHMENTS

3-POINT CONVERSION ADAPTER.....	74	GRAPPLE, TRACTOR.....	88-89
AUGER DRIVE, EXTREME, SERIES 2	75	HAY SPEARS	90
BALE SQUEEZE	76	MOUNT PLATE	90
BOX BLADE SCRAPER.....	76	PALLET FORKS	91
BLADE, GRADER, HD	77	PLOW, MOLDBOARD	92
BLADE, GRADER, DUAL-EDGE	78	POWER RAKE, HD SERIES 2.....	92
BROOM, ANGLE HD SERIES 2.....	78	POWER RAKE, EXTREME DUTY	93
BROOM, PUSH	79	POWER RAKE W/3 POINT HITCH, SEVERE DUTY	93
BUCKET, DISPENSING	79	RAKE, LANDSCAPE	94
BUCKET, ROCK.....	80	ROTOTILLER.....	95
BUCKET, SNOW & MULCH.	80	SILT FENCE INSTALLER, 3 POINT HITCH.....	96
BUCKET, TRACTOR	80	SNOW BLADE, AUTOWING.....	97
CUTTER, 4' STANDARD DUTY.....	81	SNOW BLADE, HD SERIES 2 MULTI-PURPOSE	97
CUTTER, HD, ROUND BACK.	82	SNOW BLADE, STANDARD SERIES 2 MULTI-PURPOSE...98	
CUTTER, HD, DUAL SPINDLE	83-84	SNOW PUSHER.....	98
CUTTER, FLEX-WING	85-86	SOD ROLLER.....	99
DISC HARROW	87	TRAILER SPOTTER.....	99
FINISHING MOWER	87	TREE BOOM.....	100
FLAIL MOWER, STANDARD/HEAVY DUTY.....	88	TREE PULLER.....	100



MINI ATTACHMENTS

AUGER DRIVE.....	101	FORK, HYDRAULIC PALLET.....	112
BACKHOE.....	101	GRAPPLE, BUCKET.....	112
BLADES.....	102	GRAPPLE, RAKE.....	112
HYDRAULIC BREAKER, HAMMER.....	103	GRAPPLE, ROCK BUCKET.....	113
BROOMS, ANGLE HD, SERIES 2.....	103	GRAPPLES, ROOT.....	113
BROOM, PICK-UP.....	104	LAND PLANE.....	113
BROOM, PUSH, STANDARD & HEAVY DUTY.....	104	LOG GRAPPLE.....	114
BROOM, PUSH, LIGHT DUTY.....	105	LOG SPLITTER.....	114
BRUSH CUTTER, SERIES 2.....	106	POST DRIVER, VIBRATORY.....	114
BUCKET, 4-IN-1.....	106	RAKE, POWER, STANDARD DUTY.....	115
BUCKET, DISPENSING.....	107	RAKE, POWER, HEAVY DUTY, SERIES 2.....	115
BUCKET, FRONT DUMP.....	107	ROTOTILLER, HEAVY DUTY.....	116
BUCKET, ROCK.....	107	SNOW BLOWER.....	117
BUCKET, LOW PROFILE.....	108-109	SNOW PUSHER.....	117
BUCKET, SNOW & MULCH.....	110	SOD ROLLER.....	118
BUCKET, STUMP.....	110	STUMP GRINDER.....	118
FORK, GRAPPLE.....	111	TRAILER SPOTTER.....	118
FORK, NURSERY.....	111	TREE BOOM.....	119
FORK, PALLET.....	111	TRENCHER.....	119



FORKLIFT ATTACHMENTS

INDUSTRIAL JIB.....	120	WORK PLATFORM.....	121
PUSH BROOM.....	121		



PARTS & ACCESSORIES

INTERFACE CONVERSION ADAPTERS.....	122-123	SAFETY WINDSHIELDS.....	124-125
------------------------------------	---------	-------------------------	---------



MARKETING & PROMOTIONAL PRODUCTS

LITERATURE & PROMOTIONAL ITEMS.....	126
-------------------------------------	-----



STORAGE & DISPLAY SOLUTIONS

ATTACHMENT DISPLAY STANDS.....	127
--------------------------------	-----





SKID STEER ATTACHMENTS



3-POINT CONVERSION ADAPTER

The Blue Diamond® 3-Point Conversion Adapter allows you to use your 3 point farm tractor attachments on your skid steer style universal mount. This adapter is great for moving and using farm implements that don't require a PTO! We have options available for both Category 1 and 2 hitches.

PART NUMBER	MODEL	WEIGHT
113105	Universal to 3 Pt. Hitch Conversion, CAT 1	147 lbs
113110	Universal to 3 Pt. Hitch Conversion, CAT 2	225 lbs

FEATURES INCLUDE

- Allows for quick hookup
- Strong adapter welded to a square tubular frame
- Adjustable upper hook for a perfect connection
- Powder-coated and made in the USA
- Locking levers for an easy, secure attach!



AUGER ADAPTERS

Our Blue Diamond® Auger Adapters allow you to mount Blue Diamond® Auger Bits on any Auger Drive unit. Select the dimensions and configurations that you need, and you'll be able to mix and match mounts and bits, giving you a full line of earth drilling and augering tools with full functionality and versatility!

FEATURES INCLUDE

- Strong and durable
- Available in 6 configurations
- First dimension fits drive, second dimension fits bit
- Cannot be reversed
- Easy to install and remove

PART NUMBER	MODEL	WEIGHT
205105	2" Hex Female To 2" 9/16 Rd Male	20 lbs
205110	2" Hex Female To 2" Rd Male	17 lbs
205111	2" Hex Female To 2 1/2" Hex Male	46 lbs
205115	2" 9/16 Rd Female To 2" Hex Male	15 lbs
205120	2" 9/16 Rd Female To 2" Rd Male	13 lbs
205125	2" Rd Female To 2" Hex Male	12 lbs
205130	2" Rd Female To 2" 9/16 Rd Male	12 lbs
205135	2 1/2" Hex Female To 2" Hex Male	42 lbs
205136	2 5/8" Hex Female To 2" Hex Male	45 lbs



AUGER EXTENSIONS

FIXED



PART NUMBER	MODEL	WEIGHT
205375	Fixed, 2" Hex 48" Long	58 lbs
205377	Fixed, 2 9/16" Round 48" Long	77 lbs
205380	Fixed, 2" Hex 72" Long	84 lbs
205370	Fixed, 2" Hex 24" Long	32 lbs
205365	Fixed, 2" Hex 12" Long	20 lbs
205369	Fixed, 2 9/16" Round 18" Long	40 lbs
205371	Fixed, 2" Round 24" Long	57 lbs
205382	Fixed, 2 9/16" Round 72" Long	110 lbs
205372	Fixed, 2 9/16" Round 24" Long	40 lbs
205367	Fixed, 2 9/16" Round 12" Long	21 lbs
205373	Fixed, 2" Round 48" Long	40 lbs

AUGER EXTENSIONS

VARIABLE



PART NUMBER	MODEL	WEIGHT
205315	Variable, 2" Hex 24" Long	34 lbs
205320	Variable, 2" Hex 48" Long	56 lbs
205325	Variable, 2" Hex 72" Long	77 lbs
205347	Variable, 2 9/16" Round 72"	84 lbs
205312	Variable, 2 9/16" Round 12" Long	21 lbs
205317	Variable, 2 9/16" Round 24" Long	40 lbs
205335	Variable, 2 9/16" Round 48" Long	74 lbs
205334	Variable, 2" Round 48" Long	46 lbs

AUGER BITS

HEAVY DUTY



FEATURES INCLUDE

Moderate ground conditions

- Fabricated boring head
- Hardened bolt-on teeth; standard includes gauge teeth in outside position, wisdom teeth in inside position
- Hardened fishtail point
- Heavy duty double flighting
- 4' standard length
- 2" hex, 2 9/16" round, 2" round collars available



PART NUMBER	MODEL	WEIGHT
105105	4" Diameter, Heavy Duty, W/2" Hex	37 lbs
105110	6" Diameter, Heavy Duty, W/2" Hex	45 lbs
105115	8" Diameter, Heavy Duty, W/2" Hex	76 lbs
105120	9" Diameter, Heavy Duty, W/2" Hex	85 lbs
105125	10" Diameter, Heavy Duty, W/2" Hex	100 lbs
105130	12" Diameter, Heavy Duty, W/2" Hex	113 lbs
105135	15" Diameter, Heavy Duty, W/2" Hex	132 lbs
105140	16" Diameter, Heavy Duty, W/2" Hex	136 lbs
105145	18" Diameter, Heavy Duty, W/2" Hex	166 lbs
105147	20" Diameter, Heavy Duty, W/2" Hex	182 lbs
105150	24" Diameter, Heavy Duty, W/2" Hex	210 lbs
105155	30" Diameter, Heavy Duty, W/2" Hex	278 lbs
105160	36" Diameter, Heavy Duty, W/2" Hex	372 lbs

HEAVY DUTY WITH CAST HEAD



PART NUMBER	MODEL	WEIGHT
105205	6" Diameter, Cast Head, W/2" Hex	45 lbs
105208	8" Diameter, Cast Head, W/2" Hex	90 lbs
105210	9" Diameter, Cast Head, W/2" Hex	98 lbs
105215	10" Diameter, Cast Head, W/2" Hex	113 lbs
105220	12" Diameter, Cast Head, W/2" Hex	128 lbs
105225	15" Diameter, Cast Head, W/2" Hex	139 lbs
105230	16" Diameter, Cast Head, W/2" Hex	167 lbs
105235	18" Diameter, Cast Head, W/2" Hex	204 lbs
105237	20" Diameter, Cast Head, W/2" Hex	231 lbs
105239	24" Diameter, Cast Head, W/2" Hex	272 lbs
105241	30" Diameter, Cast Head, W/2" Hex	312 lbs
105243	36" Diameter, Cast Head, W/2" Hex	430 lbs
105245	42" Diameter, Cast Head, W/2" Hex	460 lbs
105250	48" Diameter, Cast Head, W/2" Hex	550 lbs



FEATURES INCLUDE

Difficult ground conditions

- Cast steel boring head
- Hardened drive-in teeth; standard includes gauge teeth in outside position, chisel teeth in inside position
- Hardened fishtail point
- Heavy duty double flighting
- 4' standard length; 3', 5', and 6' lengths available
- 2" hex, 2 9/16" round, and 2" round collars available

ROCK BITS



PART NUMBER	MODEL	WEIGHT
105305	4" Diameter, Rock, W/2" Hex	70 lbs
105310	6" Diameter, Rock, W/2" Hex	66 lbs
105320	9" Diameter, Rock, W/2" Hex	102 lbs
105330	12" Diameter, Rock, W/2" Hex	134 lbs
105340	16" Diameter Rock, W/2" Hex	203 lbs
105345	18" Diameter, Rock, W/2" Hex	201 lbs
105350	24" Diameter, Rock, W/2" Hex	291 lbs
105355	30" Diameter, Rock, W/2" Hex	340 lbs
105360	36" Diameter, Rock, W/2" Hex	395 lbs

FEATURES INCLUDE

Rock, asphalt, and frozen ground

- Solid rock and concrete
- Cast tooth pockets
- Drive-in carbide bullet teeth
- 3/4" thick boring head
- 4' standard length
- 2" hex, 2 9/16" round, and 2" round collars available



TREE BITS



PART NUMBER	MODEL	WEIGHT
105405	18-9" Diameter, Tree, W/2" Hex	120 lbs
105410	24-12" Diameter, Tree, W/2" Hex	176 lbs
105415	30-15" Diameter, Tree, W/2" Hex	264 lbs
105420	36-18" Diameter, Tree, W/2" Hex	286 lbs
105425	42-18" Diameter, Tree, W/2" Hex	432 lbs
105430	48-24" Diameter, Tree, W/2" Hex	449 lbs

FEATURES INCLUDE

Tree and shrub planting

- Fabricated boring head
- Hardened bolt-on teeth; standard includes gauge teeth in outside position, wisdom teeth in inside position
- Hardened fishtail point
- Heavy duty double flighting
- 4' standard length; 3', 5', and 6' lengths available
- 2" hex, 2 9/16" round, and 2" round collars available



AUGER DRIVE EXTREME DUTY - SERIES 2

Blue Diamond® Extreme Duty Series 2 Auger Drive offers the ultimate in performance, quality, and cost effectiveness. Designed with high-grade materials and innovation, this design allows the gearbox to go down the hole, maximizing drilling depth while eliminating downtime. These drives are perfect for drilling and augering in most ground conditions.



PART NUMBER	MODEL	BEST FLOW	WEIGHT
305705	EX1, W/2" Hex Shaft	8-11 GPM	260 lbs
305708	EX2, W/2" Hex Shaft	12-16 GPM	277 lbs
305712	EX3, W/2" Hex Shaft	17-20 GPM	282 lbs
305715	EX4, W/2" Hex Shaft	19-23 GPM	342 lbs
305720	EX4HF, W/2" Hex Shaft	21-26 GPM	337 lbs

See chart on Page 64 for more information.

FEATURES INCLUDE

- Compact high torque manufactured gearbox
- 2-piece shaft design ensures maximum side load ratings
- Lifetime shaft pull-out warranty, 5-year planetary drive warranty, 3-year hydraulic motor warranty, and 1-year mount and mount components warranty

AUGER MOUNT TELESCOPIC

Blue Diamond® Attachments' piling & drilling mounts increase your reach for added drilling depth or helical pile installation. These extension mounts use only the highest quality steel and strict quality control. These telescopic extension mounts have a retracted length of 78" and are extendable by 36".



PART NUMBER	MODEL	WEIGHT
105780	Mount	359 lbs
105781	Transport Stand	255 lbs
205788	14" Hose Set 1/2" Couplers	20 lbs
205789	14" Hose Set 3/4" Couplers	20 lbs
205790	14" Hose Set 1/2" Couplers w/ Pressure Gauges	20 lbs
205791	14" Hose Set 3/4" Couplers w/ Pressure Gauges	20 lbs

Optional Transport Stand (105781) sold separately.

FEATURES INCLUDE

- 78" Retracted Length
- Extendable by 36"
- Minimum Skid Steer ROC 1800 lbs
- Maximum Auger Drive Torque 7000 ft/lbs
- Maximum Auger Bit Weight 220 lbs
- Transport Stand – Sold Separately
- Longer Hose Set required – Sold Separately
- Hose sets have Pressure Gauge Option

BACKHOE

The Blue Diamond® Backhoe is a quick and easy way to dig trenches with a skid steer. This powerful unit uses the biggest cylinder in the industry with the largest bucket capacity. The linkage geometry gives exceptional bucket rotation and breakout force.



FEATURES INCLUDE

- 3 1/2" bore, 20" stroke cylinder
- Linkage between cylinder and bucket
- Includes flat face couplers
- Bucket sizes comes in 9", 12", 18", and 24"
- Heavy duty cast replaceable teeth
- Grease fittings on all pivot points
- Quick off and on machine
- No specific machine requirements
- Easy to operate
- Requires no electrical hookups



PART NUMBER	MODEL	WEIGHT
130005	Backhoe, Hyd (No Bucket)	391 lbs
130009	8" Backhoe Bucket	103 lbs
130010	9" Backhoe Bucket	103 lbs
130015	12" Backhoe Bucket	139 lbs
130020	18" Backhoe Bucket	169 lbs
130025	24" Backhoe Bucket	202 lbs
130027	30" Backhoe Bucket	202 lbs

Features: 3 1/2" bore, 20" stroke cylinder, large capacity bucket (hose & couplers included)

BALE SQUEEZE HYDRAULIC ROUND

The Blue Diamond® Bale Squeeze is an excellent alternative to a bale spear, especially when using wrapped bales. This versatile attachment can pick up bales whether they are sitting flat or are on their side.



PART NUMBER	MODEL	WEIGHT
111105	Bale Squeeze	400 lbs
211110	Optional Bolt-On Grippers*	60 lbs

Optional grippers help when handling wet or plastic wrapped bales.

FEATURES INCLUDE

- Strong tubular design, handles round bales
- 2,000 lb capacity
- Flat-face couplers
- Opens to 72" for handling up to 60" bales
- Equalizer bar standard
- Use on skid steers or tractors with universal mount





6-WAY DOZER BLADE



The Blue Diamond® 6-Way Dozer Blade for skid steers is extremely rugged, easy to use, and offers superior visibility. It has a bolt-on edge, skid shoes, and heavy duty cylinders. Using a proven pivot system, it can tilt 10° and angle 30°. A blade extension is available for 8" of added height. It converts to a snow plow by pulling 2 pins and adding a height extension and trip springs. Don't settle for anything less!



FEATURES INCLUDE

- Heavier moldboard design
- Even heavier cylinders
- Electrical, now compatible with Bobcat, 7-pin OEM connector available
- Grease fittings on all cylinder pins
- Added protection on electrical and hydraulic valve components
- Tried and proven tilt system
- Optional trip springs
- Trip override pin
- Replaceable skid shoes
- Replaceable bolt-on edge
- Optional 8" blade height extension

PART NUMBER	MODEL	ANGLED WIDTH	WEIGHT
123065	Heavy Duty 72"	62.25"	1,012 lbs
123070	Heavy Duty 84"	72.5"	1,040 lbs
123075	Heavy Duty 96"	82.875"	1,068 lbs
223700	Trip Springs Kit (Set Of 4)	-	14 lbs

BOX SCRAPER RIPPER

The Blue Diamond® Skid Steer Box Scraper Ripper is the perfect skid steer attachment for reconditioning gravel roads and driveways. The rippers will resurface the gravel that is buried in the ground over time. While the cutting edges will smooth out and level the gravel.



FEATURES INCLUDE

- Replaceable and reversible cutting edges
- Replaceable ripper shanks
- Adjustable ripper tines
- Powder coated
- American made

PART NUMBER	MODEL	WEIGHT
115520	Box Grader with Rippers and Replaceable Cutting Edges 60"	648 lbs
115525	Box Grader with Rippers and Replaceable Cutting Edges 72"	778 lbs
115530	Box Grader with Rippers and Replaceable Cutting Edges 84"	907 lbs
115535	Box Grader with Rippers and Replaceable Cutting Edges 90"	1,037 lbs

HYDRAULIC BREAKER HAMMER



Our 5 year quest to develop a superior hydraulic breaker is now available from Blue Diamond®. This “hammer” design offers technology, simplicity, reliability, ease of setup, and service support. With no more downtime, you can get started on your demolition, construction, and quarry jobs now.

FEATURES INCLUDE

- 3-year warranty
- Mono-block design / no tie rods
- Anti-blank firing system
- Hydraulic brake
- No re-gassing needed
- Only 2 internal moving parts
- 2 speed control / variable stroke
- Quiet operation
- Self-regulating
- Body bushings around piston

PART NUMBER	MODEL	WORKING PRESSURE	MAX OIL FLOW	FREQUENCY (BPM)	OPERATING WEIGHT	TOOL DIAMETER	ENERGY CLASS	CARRIER WEIGHT	(PSI) BACK PRESSURE
135005	HB50	1,750	7	1,200	132 lbs	1.5	100	1,500-2,650 lbs	290-360
135009	HB95		11		220 lbs	1.8	200	2,650-4,000 lbs	
135016	HB165		13		370 lbs	2.2	400	4,000-6,600 lbs	
135021	HB210		16	1,100	463 lbs	2.5	500	6,100-9,900 lbs	
135030	HB300		21.2		661 lbs	2.9	700	8,800-15,500 lbs	
135040	HB400		29.2	900	882 lbs	3.1	1,000	13,500-20,900 lbs	
135053	HB530	32	1,169 lbs		3.3	1,200	17,650-25,350 lbs		

BREAKER CUTAWAY

ACCUMULATOR:

The large dimension accumulator with diaphragm supplies power to the breaker and protects the excavator hydraulic pump and pipeline from damage due to the backshock blows

ISOLATION:

An isolation with vulcanized polyurethane between the metal case and the monoblock drastically reduced noise and vibrations

MONOBLOCK:

The absence of a tie rod increases reliability and makes eventual servicing more simple and economical

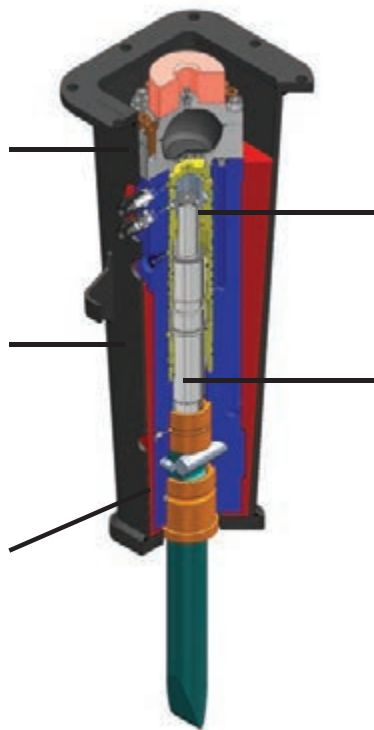

BODY BUSHINGS:

In case of a damaged piston, body bushings protect the monoblock

HYDRAULIC BRAKE:

A hydraulic brake on the piston prohibits the breaker from harmful blank firing

BROOMS ANGLE SEVERE DUTY SERIES 2

The Blue Diamond® Severe Duty Series 2 Angle Broom is a powerful attachment for the serious user. It has been engineered for daily use in tough conditions. Everywhere you look on this broom, you will see quality and ingenuity.



PART NUMBER	MODEL	ANGLED WIDTH	WEIGHT
116408	60" Manual Angle	48.7"	995 lbs
116413	72" Manual Angle	59.2"	1,125 lbs
116418	84" Manual Angle	69.3"	1,300 lbs
116423	96" Manual Angle	79.7"	1,450 lbs
116410	60" Hydraulic Angle	48.7"	805 lbs
116415	72" Hydraulic Angle	59.2"	944 lbs
116420	84" Hydraulic Angle	69.3"	987 lbs
116425	96" Hydraulic Angle	79.7"	995 lbs



OPTIONAL WATER KIT

FEATURES INCLUDE

- Hydraulic angle and bristle operate simultaneously
- Oversized main shaft spindles
- Massive bearings
- Bidirectional motor
- Welded heavy duty cylinder
- Grease fittings on pivot points
- 32" bristles with poly, steel, or poly/steel mix available
- 7-pin, 8-pin, and 14-pin OEM connector available
- Optional water kit



32" POLY, POLY/STEEL MIX, STEEL



BROOMS ANGLE HEAVY DUTY SERIES 2

Our Blue Diamond® Heavy Duty Series 2 Angle Broom is available in manual and hydraulic angle options. A simple-to-use control comes with the hydraulic angle model for control from inside your cab. The bristles are available in poly, steel, or poly/steel mix and are protected by retractable legs when not in use.



PART NUMBER	MODEL	WEIGHT
116207	60" Manual Angle	620 lbs
116212	72" Manual Angle	665 lbs
116217	84" Manual Angle	811 lbs
116222	96" Manual Angle	980 lbs
116205	60" Hydraulic Angle (Req Wiring Harness)	652 lbs
116210	72" Hydraulic Angle (Req Wiring Harness)	687 lbs
116215	84" Hydraulic Angle (Req Wiring Harness)	756 lbs
116220	96" Hydraulic Angle (Req Wiring Harness)	824 lbs



OPTIONAL
WATER KIT

Attachment is weighed without mount.

FEATURES INCLUDE

- 60", 72", 84", and 96" widths
- 26" bristles, poly, steel, or poly/steel mix
- Manual or hydraulic options
- Stand protects bristles when not in use
- 7-pin, 8-pin, and 14-pin OEM connector available
- 1-year warranty
- Optional water kit
- Mini model available
- 30° pivot angle



26" POLY, POLY/STEEL MIX, STEEL WAFERS



BROOMS - PICK UP SERIES 2



FEATURES INCLUDE

- Predrilled for optional water kit
- Mounts for gutter brush included
- Bolt-on rubber skirting to contain debris
- Motor and shaft guards
- 1 1/2" x 7" Zinc height-adjustment pins with 4 positions
- Heavy duty dump stops
- Grease fittings on all pivot points and bearings
- Steps mounted on back of broom for entering and exiting the host machine



OPTIONAL GUTTER BRUSH

PART NUMBER	MODEL	WEIGHT
116512	60" Pickup Broom, Series 2	945 lbs
116517	72" Pickup Broom, Series 2	1,390 lbs
116522	84" Pickup Broom, Series 2	1,585 lbs
116527	96" Pickup Broom, Series 2	1,765 lbs
116555	Optional Gutter Brush	128 lbs



WATER KIT RUNNING

BROOMS - PUSH STANDARD & HEAVY DUTY

This incredible broom will amaze you! Clean up job sites, push light snow, sweep leaves, squeegee water, or groom ball fields. Add our heavy duty magnet for picking up screws, nails, and other steel debris.

FEATURES INCLUDE

- Standard Duty comes with 8 rows of bristles
- Heavy Duty has 11 rows of bristles
- Heavy Duty models are available in 60", 72", or 96" widths
- Standard Duty models are available in 60" and 72" widths



PART NUMBER	MODEL	WEIGHT	BRISTLES
316030	60" Push Standard Duty	158 lbs	8 rows
316035	72" Push Standard Duty	180 lbs	8 rows
316040	60" Push Heavy Duty	216 lbs	11 rows
316045	72" Push Heavy Duty	262 lbs	11 rows
316055	96" Push Heavy Duty	535 lbs	11 rows
116020	Forklift Mount (HD Model Req 116027)	52 lbs	—
116026	Skid Steer Mount (HD Model Req 116027)	187 lbs	—

BRUSH CUTTER 84" DUAL SPINDLE MOTOR

The Blue Diamond® Dual Motor Brush Cutter is in a class of its own! Featuring a new floating deck design, this cutter can cover the uneven ground with ease. The front wheels are adjustable to meet whatever cut height you need. It leaves a very neat finish when mowing grass, and can also cut up to 3" material in the brush.



PART NUMBER	MODEL	REQUIRED FLOW	WEIGHT
103920	84" Dual 80 CC Motor	15-22 GPM	1,865 lbs
103930	84" Dual 125 CC Motor	23-30 GPM	1,865 lbs

Includes couplers, direct drive

FEATURES INCLUDE

- 84" cutting width
- Adjustable height wheels
- Floating deck design for uneven ground
- Grease fittings on all pivots
- 4 double sided blades
- Cuts 3" material
- 1-year warranty



BRUSH CUTTER HEAVY DUTY

The Blue Diamond® Heavy Duty Brush Cutter is a high-performance cutter that is priced right for the everyday non-commercial user. It mows very well in grass and cuts up to 3" diameter brush with ease!



PART NUMBER	MODEL	REQUIRED FLOW	WEIGHT
103004	60" HD Brush Cutter	11-16 GPM	940 lbs
103007	60" HD Brush Cutter	16-26 GPM	940 lbs
103012	72" HD Brush Cutter	16-26 GPM	1,552 lbs

FEATURES INCLUDE

- Available in 60" and 72" cutting widths
- Chain curtain minimizes discharge
- Perimeter wire/vine guard on blade carrier
- 3 cutting blades
- Dual external crossover relief valves
- 4000 Series geroler motor
- Dual-direction cutting
- 1-year warranty

BRUSH CUTTER EXTREME DUTY OPEN/CLOSED FRONT



PART NUMBER	MODEL	REQUIRED FLOW	WEIGHT
103015	60" Low Flow-Closed Front	16-26 GPM	1,235 lbs
103020	72" Low Flow-Closed Front	16-26 GPM	1,617 lbs
103016	60" Low Flow-Open Front	16-26 GPM	1,220 lbs
103025	72" Low Flow-Open Front	16-26 GPM	1,547 lbs
103017	60" High Flow-Open Front	27-40 GPM	1,220 lbs
103023	72" High Flow-Closed Front	27-35 GPM	1,585 lbs
103024	72" High Flow-Closed Front	36-45 GPM	1,591 lbs
103030	72" High Flow-Open Front	27-35 GPM	1,555 lbs
103032	72" High Flow-Open Front	36-45 GPM	1,555 lbs



OPEN-FRONT



CLOSED-FRONT



60" STANDARD FLOW:

- 3 double-sided blades
- 3/4" thick blade carrier
- 4000 Series geroler motor
- 6" diameter cutting capacity
- 16 GPM–26 GPM flow range
- Dual-direction cutting

72" STANDARD FLOW:

- 4 double-sided blades
- 3/4" thick blade carrier
- 4000 Series geroler motor
- 6" diameter cutting capacity
- 16 GPM–26 GPM flow range
- Dual-direction cutting

72" HIGH FLOW:

- 4 double-sided blades
- 3/4" thick blade carrier
- 6000 Series geroler motor
- 8" diameter cutting capacity
- 27 GPM–45 GPM flow range
- Dual-direction cutting

BRUSH CUTTER SWING ARM

The Blue Diamond® Swing Arm Cutter is a great implement to add to your collection. It is designed for cutting banks, right of ways, and fence lines. The cutter also works great for clearing pond banks and cutting trails. The Swing Arm Cutter provides significant reach advantage over our typical cutter.

PART NUMBER	MODEL	REQUIRED FLOW	WEIGHT
103870	Brush Cutter Swing Arm	14-20 GPM	845 lbs
103875	Brush Cutter Swing Arm	17-30 GPM	1,203 lbs



DO NOT USE WITHOUT SAFETY WINDSHIELD



FEATURES INCLUDE

- Reach advantage over our typical cutter
- Can be used as a side cutter
- Direct drive piston motor with max 4000 PSI
- 3" x 16" tilt cylinders
- 5/8" AR400 Blades
- 44" cut
- Requires case drain
- Optional universal, 7-pin, 8-pin, or 14-pin wiring harnesses are available

BRUSH CUTTER SEVERE DUTY SERIES 2

The incredible power and versatility of the Blue Diamond® Severe Duty Series 2 Brush Cutter will all but remove the need for a mulching head. Its 10” cutting capacity and incredible performance in grass make this brutally tough unit the top in its class. Using the highest quality piston motor on the market, the torque throughout its flow range is unmatched. The visible pressure gauge keeps you aware of the workload and keeps you working at peak performance, increasing productivity tremendously! Adjustable skid shoes allow the cutting height to be adjusted. The mammoth 1” thick blade carrier weighs over 500 lbs and has a serrated edge to help with mulching and destroying fence wire that often takes out other brush cutters. The innovative debris covers prevent brush and other materials from building up on the top of the deck. Keeping this surface clear of debris ensures maximum life of the durable powder coat as well as adding safety for entering and exiting the machine.



**10” CUTTING
CAPACITY**



500 LB BLADE CARRIER

FEATURES INCLUDE

- 72” cutting width
- 4 double-sided blades
- Piston motor
- 1” thick blade carrier with serrated edge
- Visible pressure gauge to monitor workload
- Adjustable bolt-on skid shoes
- Easy machine entry
- Dual redundant hydraulic protection for the motor

PART NUMBER	MODEL	REQUIRED FLOW	WEIGHT
103122	72" Severe Duty, 150 CC	16-26 GPM	1,957 lbs
103127	72" Severe Duty, 200 CC	27-35 GPM	2,224 lbs
103132	72" Severe Duty, 250 CC	35-45 GPM	2,250 lbs



BUCKETS 4-IN-1



The Blue Diamond® 4-in-1 Bucket will make a skid steer or compact track loader into a versatile machine. Use as a grapple for moving logs or debris, pushing dirt with the blade, digging with the bucket, and backdragging with the open bucket like a box blade. The 4-in-1 uses 2 powerful cylinders and can be greased on all pivot points. A pilot-operated check-valve to control drifting is available.



PART NUMBER	MODEL	STRUCK CAPACITY	WEIGHT
108780	66" 4-In-1, W/Smooth Edge	13.9 CU FT	862 lbs
108785	72" 4-In-1, W/Smooth Edge	15.2 CU FT	908 lbs
108790	78" 4-In-1, W/Smooth Edge	16.5 CU FT	979 lbs
108795	84" 4-In-1, W/Smooth Edge	17.7 CU FT	1,004 lbs
108776	60" 4-In-1, W/Teeth	12 CU FT	855 lbs
108781	66" 4-In-1, W/Teeth	13.9 CU FT	750 lbs
108786	72" 4-In-1, W/Teeth	15.2 CU FT	981 lbs
108791	78" 4-In-1, W/Teeth	16.5 CU FT	959 lbs
108796	84" 4-In-1, W/Teeth	17.7 CU FT	1,190 lbs

BUCKETS DISPENSING



The Blue Diamond® Dispensing Bucket is great for any flowable material feed to concrete. The hopper has splash guards around the top to contain material while traveling on rough terrain. The heavy duty chute is enclosed at the back to control the flow and is removable for transportation or storage.

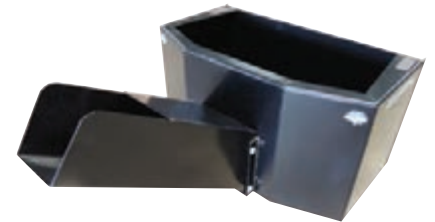

FEATURES INCLUDE

- Available with 1/2 yard or 3/4 yard hopper with tapered front
- Removable chute for cleaning and storage
- Splash guard around top line
- Available with or without hydraulic door
- 1-year warranty

PART NUMBER	MODEL	WEIGHT
110005	1/2 Yard Dispensing Bucket	393 lbs
110010	1/2 Yard Dispensing Bucket W/Hydraulic Door	403 lbs
110035	3/4 Yard Dispensing Bucket	452 lbs
110040	3/4 Yard Dispensing Bucket W/Hydraulic Door	477 lbs

BUCKETS DUMPSTER



The Blue Diamond® Dumpster Bucket is very handy around a job site for collecting trash. Acts like a large garbage can that can easily hook onto your skid steer and be dumped into a truck or larger dumpster. Also works well for carrying mulch, potted trees, and tools across a job site.

PART NUMBER	MODEL	STRUCK CAPACITY	WEIGHT
108898	50" Dumpster Bucket	27.6 CU FT	360 lbs
108899	66" Dumpster Bucket	37.3 CU FT	430 lbs
108900	72" Dumpster Bucket	40.5 CU FT	510 lbs
108902	84" Dumpster Bucket	47.3 CU FT	595 lbs

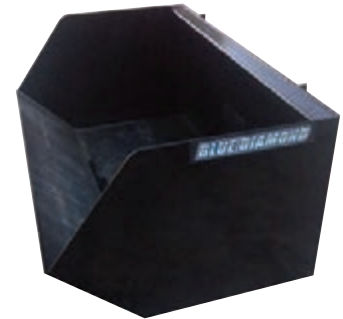

FRONT DUMP

PART NUMBER	MODEL	STRUCK CAPACITY	WEIGHT
108801	72" Front Dump Bucket	25.1 CU FT	935 lbs
108803	78" Front Dump Bucket	27.1 CU FT	965 lbs
108805	84" Front Dump Bucket	29.1 CU FT	1,009 lbs
108815	96" Front Dump Bucket	48.1 CU FT	1,100 lbs

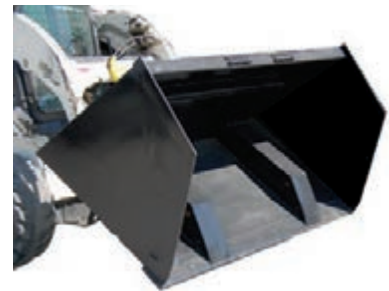

ROCK - STANDARD & EXTREME DUTY

FEATURES INCLUDE

- 3" spacing between tines
- Available in 66", 72", 78", and 84" widths
- 3/8" or 1/2" Thick tines
- Available with Euro/Global mount

PART NUMBER	MODEL	TINE THICKNESS	WEIGHT
108320	66" Standard Duty Rock Bucket	3/8"	424 lbs
108335	72" Standard Duty Rock Bucket	3/8"	465 lbs
108350	78" Standard Duty Rock Bucket	3/8"	512 lbs
108405	66" Extreme Duty Rock Bucket	1/2"	615 lbs
108410	72" Extreme Duty Rock Bucket	1/2"	615 lbs
108415	78" Extreme Duty Rock Bucket	1/2"	656 lbs
108420	84" Extreme Duty Rock Bucket	1/2"	690 lbs



BUCKETS

GENERAL PURPOSE

The Blue Diamond® General Purpose Buckets for skid steers are available in a variety of configurations. We offer weld-on cutting edge, bolt-on cutting edge, teeth, toothbar, or a long-bottom version. These well-engineered, low-profile buckets offer a powerful breakout force and great visibility. Buckets up to 72" wide use 3/16" material back and bottom. The 78" and larger sizes use 1/4" material. All standard buckets are 20" tall and use a 3/4" by 6" cutting edge. The standard bottom is 30" front to back, and the long-bottom bucket is 36".



TOOTH BUCKET

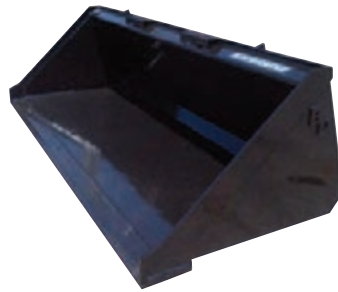

SMOOTH BUCKET



BUCKET WITH SERRATED
BOLT-ON-EDGE

PART NUMBER	MODEL	STRUCK CAPACITY	WEIGHT
108090	60" Low Profile-Smooth	10.8 CU FT	334 lbs
108095	60" Low Profile-Tooth	10.8 CU FT	384 lbs
108100	66" Low Profile-Smooth	12.2 CU FT	354 lbs
108105	66" Low Profile-Tooth	12.2 CU FT	409 lbs
108110	72" Low Profile-Smooth	13.2 CU FT	378 lbs
108115	72" Low Profile-Tooth	13.2 CU FT	437 lbs
108120	78" Low Profile-Smooth	14.3 CU FT	408 lbs
108125	78" Low Profile-Tooth	14.3 CU FT	460 lbs
108130	84" Low Profile-Smooth	15.7 CU FT	436 lbs
108135	84" Low Profile-Tooth	15.7 CU FT	515 lbs
108140	60" Low Profile-Long Bottom-Smooth	15.7 CU FT	385 lbs
108145	60" Low Profile-Long Bottom-Tooth	15.7 CU FT	434 lbs
108150	66" Low Profile-Long Bottom-Smooth	17.3 CU FT	426 lbs
108155	66" Low Profile-Long Bottom-Tooth	17.3 CU FT	472 lbs
108160	72" Low Profile-Long Bottom-Smooth	18.6 CU FT	446 lbs
108165	72" Low Profile-Long Bottom-Tooth	18.6 CU FT	505 lbs
108170	78" Low Profile-Long Bottom-Smooth	20 CU FT	441 lbs
108180	84" Low Profile-Long Bottom-Tooth	22 CU FT	505 lbs

BUCKETS

LOW PROFILE, SEVERE DUTY

The Blue Diamond® Severe Duty Bucket is among the heaviest duty skid steer buckets on the market. It is available in 66", 72", 78", 84", or 90" widths, low profile, and/or, high capacity. It is constructed from heavy gauge steel consisting of a 1/2" bottom, double-layer 1/4" back, and a 1" x 8" cutting blade.

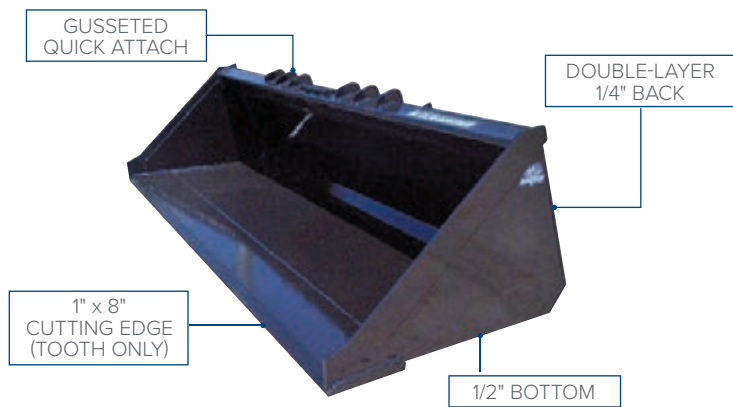

TOOTH BUCKET



BUCKET WITH SERRATED
BOLT-ON-EDGE



SMOOTH BUCKET

PART NUMBER	MODEL	STRUCK CAPACITY	WEIGHT
108260	66" Low Profile, Severe Duty, Smooth	11.4 CU FT	650 lbs
108263	66" Low Profile, Severe Duty, Tooth	11.4 CU FT	675 lbs
108270	72" Low Profile, Severe Duty, Smooth	11 CU FT	710 lbs
108273	72" Low Profile, Severe Duty, Tooth	11 CU FT	724 lbs
108275	78" Low Profile, Severe Duty, Smooth	12 CU FT	690 lbs
108277	78" Low Profile, Severe Duty, Tooth	12 CU FT	757 lbs
108280	84" Low Profile, Severe Duty, Smooth	12.9 CU FT	738 lbs
108282	84" Low Profile, Severe Duty, Tooth	12.9 CU FT	813 lbs
108283	90" Low Profile, Severe Duty Tooth	18.8 CU FT	925 lbs
108284	72" Low Profile, Severe Duty, Smooth-Long Bottom	15.2 CU FT	732 lbs
108285	72" Low Profile, Severe Duty, Tooth-Long Bottom	15.2 CU FT	774 lbs
108286	78" Low Profile, Severe Duty, Smooth-Long Bottom	16.47 CU FT	759 lbs
108287	78" Low Profile, Severe Duty, Tooth-Long Bottom	16.47 CU FT	846 lbs
108290	84" Low Profile, Severe Duty, Smooth-Long Bottom	17.74 CU FT	853 lbs
108293	84" Low Profile, Severe Duty, Tooth-Long Bottom	17.5 CU FT	892 lbs
108296	90" Low Profile, Severe Duty, Tooth-Long Bottom	18.8 CU FT	875 lbs



BUCKETS

TURKEY LITTER, HEAVY DUTY

The Blue Diamond® Turkey Litter bucket allows you to move large volumes of light material in one scoop. These large capacity buckets were originally designed to clean out turkey farms, but also work great for sawdust, corn, or other light materials.



FEATURES INCLUDE

- 40" high back
- 42" deep front to back
- Reinforced back and floor
- Pre-drilled for bolt-on edge option
- 1/4" wrap thickness

PART NUMBER	MODEL	STRUCK CAPACITY	WEIGHT
108745	78" HD Turkey Litter Bucket, 1/4" Wrap	1.8 yards ³	750 lbs
108750	84" HD Turkey Litter Bucket, 1/4" Wrap	2.0 yards ³	890 lbs
108751	96" HD Turkey Litter Bucket, 1/4" Wrap	2.2 yards ³	890 lbs

BUCKETS

UTILITY



The Blue Diamond® Utility Bucket is very rugged. It offers more capacity than a standard low-profile bucket yet does not get as cumbersome as a high-capacity bucket. Designed for larger machines, it can handle the horsepower and not get overloaded as fast as some OEM buckets. The rolled back on the inside allows the bucket to clean out easier yet the rear heel still offers excellent backdragging and leveling capabilities.



SMOOTH BUCKET
34"D X 22"H



TOOTH BUCKET

PART NUMBER	MODEL	STRUCK CAPACITY	WEIGHT
108960	72" Smooth W/Bolt-On Edge	13.5 CU FT	610 lbs
108965	72" Tooth	13.5 CU FT	610 lbs
108970	78" Smooth W/Bolt-On Edge	14.58 CU FT	670 lbs
108975	78" Tooth	14.58 CU FT	656 lbs
108980	84" Smooth W/Bolt-On Edge	15.66 CU FT	695 lbs
108985	84" Tooth	15.66 CU FT	678 lbs
108987	90" Smooth W/Bolt-On Edge	16.74 CU FT	670 lbs

FEATURES INCLUDE

- 34" deep front to back
- 22" high back

BUCKETS

UTILITY - HIGH CAPACITY



FEATURES INCLUDE

- 1/2" Rolled back
- 5/8" Thick cutting Edge



SMOOTH BUCKET

PART NUMBER	MODEL	STRUCK CAPACITY	WEIGHT
108944	72" High-Capacity Utility - Smooth w/BOE	19.71 CU FT	785 lbs
108946	72" High-Capacity Utility - Tooth	19.71 CU FT	785 lbs
108948	78" High-Capacity Utility - Smooth w/BOE	21.33 CU FT	785 lbs
108950	78" High-Capacity Utility - Tooth	21.33 CU FT	785 lbs
108952	84" High-Capacity Utility - Smooth w/BOE	23 CU FT	785 lbs
108954	84" High-Capacity Utility - Tooth	26 CU FT	792 lbs
108956	90" High-Capacity Utility - Smooth w/BOE	25 CU FT	792 lbs
108957	90" High-Capacity Utility - Tooth	25 CU FT	795 lbs
108958	96" High-Capacity Utility - Smooth w/BOE	26.19 CU FT	802 lbs
108959	96" High-Capacity Utility - Tooth	26.19 CU FT	802 lbs



TOOTH BUCKET

UTILITY - HIGH CAPACITY | HIGH BACK

The Blue Diamond High Capacity High Back Utility Buckets are key for productivity on the job site. With a durable reinforced back and massive capacity, these buckets are sure to meet whatever demands you can throw at them. The mesh in the back provides exceptional visibility, while the optional bolt on side cutters help scrape materials into the bucket.



PART NUMBER	MODEL	WEIGHT
108946-HB	72" High-Back/High-Capacity Utility - Tooth	930 lbs
108950-HB	78" High-Back/High-Capacity Utility - Tooth	965 lbs
108954-HB	84" High-Back/High-Capacity Utility - Tooth	1,033 lbs
108957-HB	90" High-Back/High-Capacity Utility - Tooth	1,035 lbs
108959-HB	96" High-Back/High-Capacity Utility - Tooth	1,055 lbs
108944-HB	72" High-Back/High-Capacity Utility - Smooth w/BOE	945 lbs
108948-HB	78" High-Back/High-Capacity Utility - Smooth w/BOE	980 lbs
108952-HB	84" High-Back/High-Capacity Utility - Smooth w/BOE	1,015 lbs
108956-HB	90" High-Back/High-Capacity Utility - Smooth w/BOE	1,050 lbs
108958-HB	96" High-Back/High-Capacity Utility - Smooth w/BOE	1,070 lbs

BUCKETS SCREENING

The Blue Diamond® Screening Bucket is used for the screening, aerating, separating and mixing of soils, aggregates, wood chip and compost. The efficient screening process is created by the star rotors agitating the material, causing the fines to flow through the rotating stars leaving the oversized material in the bucket. A hydraulic flow regulator is included to maintain correct RPM for poly stars.



FEATURES INCLUDE

- 1" or smaller material will flow through
- Horizontal shafts, fitted with poly stars that rotate in the same upwards direction
- Hardened steel cutting edge
- 2-position mount plate
- Hoses and couplers included
- Mounts available to fit most machines
- 1-year warranty

PART NUMBER	MODEL	WEIGHT
145015	60" Skid Steer	1,320 lbs
145050	Screening Bucket Mount Skid Steer	95 lbs

* Optional comb kits.

SLAB



FEATURES INCLUDE

- 3/4" sides
- 1" x 8" cutting edge
- Cast replaceable teeth
- Reinforced quick attach for prying
- Powder coat paint



PART NUMBER	MODEL	WEIGHT
108895	Slab Bucket	600 lbs

STUMP



PART NUMBER	MODEL	WEIGHT
102015	Stump Bucket, Severe Duty Curved Bottom	443 lbs
102006	Stump Bucket, Extreme W/Grapple	475 lbs
102008	Stump Bucket, Extreme W/Grapple, No Teeth	535 lbs
102010	Stump Bucket, Extreme Grapple Kit	156 lbs

For digging stumps, shrubs, and trenches.



SNOW & MULCH - SPECIAL CAPACITY

PART NUMBER	MODEL	STRUCK CAPACITY	WEIGHT
108513	48" Snow & Mulch	1 YARD	507 lbs
108525	60" Snow & Mulch	1 YARD	509 lbs
108565	84" Snow & Mulch	1 1/2 YARD	601 lbs
108585	96" Snow & Mulch	1 1/2 YARD	728 lbs

Great for loading short bed trucks.



BUCKETS

SNOW & MULCH - STANDARD DUTY

PART NUMBER	MODEL	STRUCK CAPACITY	WEIGHT
108520	60" Snow & Mulch, 3/16" Wrap	21 CU FT	450 lbs
108530	66" Snow & Mulch, 3/16" Wrap	22.9 CU FT	468 lbs
108540	72" Snow & Mulch, 3/16" Wrap	25 CU FT	508 lbs
108545	78" Snow & Mulch, 3/16" Wrap	27 CU FT	550 lbs
108550	84" Snow & Mulch, 3/16" Wrap	29.1 CU FT	605 lbs
108570	90" Snow & Mulch, 3/16" Wrap	31.2 CU FT	601 lbs
108580	96" Snow & Mulch, 3/16" Wrap	34.5 CU FT	767 lbs
108590	102" Snow & Mulch, 3/16" Wrap	35 CU FT	728 lbs



38"D X 26"H

TECH TIP

The "wrap" is the back and bottom of a bucket.

SNOW & MULCH - HEAVY DUTY

PART NUMBER	MODEL	STRUCK CAPACITY	WEIGHT
108620	60" Snow & Mulch, HD, 1/4 Wrap	21 CU FT	532 lbs
108630	66" Snow & Mulch, HD, 1/4 Wrap	22.9 CU FT	550 lbs
108640	72" Snow & Mulch, HD, 1/4 Wrap	25 CU FT	575 lbs
108650	78" Snow & Mulch, HD, 1/4 Wrap	27 CU FT	805 lbs
108660	84" Snow & Mulch, HD, 1/4 Wrap	29.1 CU FT	875 lbs
108670	90" Snow & Mulch, HD, 1/4 Wrap	31.2 CU FT	950 lbs
108680	96" Snow & Mulch, HD, 1/4 Wrap	34.5 CU FT	1,000 lbs
108682	102" Snow & Mulch, HD, 1/4 Wrap	36 CU FT	1,115 lbs



38"D X 26"H

SNOW & MULCH - HIGH BACK

PART NUMBER	MODEL	WEIGHT
108701	60" Snow & Mulch, High Back With Mesh	491 lbs
108702	72" Snow & Mulch, High Back With Mesh	553 lbs
108700	78" Snow & Mulch, High Back With Mesh	615 lbs
108705	84" Snow & Mulch, High Back With Mesh	724 lbs
108710	96" Snow & Mulch, High Back With Mesh	754 lbs
108715	102" Snow & Mulch, High Back With Mesh	771 lbs



38"D X 32"H

Ribs inside to strengthen floor & back. 3/16" wrap, 3/8" edge.





COLD PLANER



This premium Blue Diamond® Cold Planer uses the most trusted components in the industry, from the Sauer piston motor to the Fairfield planetary hub featured in the high-flow models. The high-end components with the highly engineered design make this cold planer among the most trusted units available for a skid steer! Using the Rocket Fin tooth from the factory and a V tooth pattern setup, vibration is reduced and productivity is greatly increased! The adjustable, independent side shoes provide fine adjustment for grade control on the high-flow cold planers. A huge access cover allows easier tooth replacement (reducing tooth change time by up to 50% over competitors), which provides a much safer way to change the teeth!

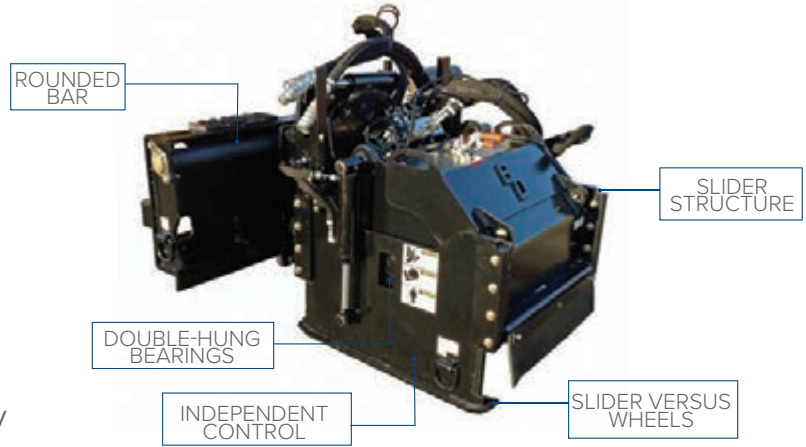

PART NUMBER	MODEL	WEIGHT	MIN PSI
160220-HP	16" High Flow, 27-45 GPM	1,770 lbs	2,450-5,000
160225	18" High Flow, 24-45 GPM	1,805 lbs	2,000-3,500
160225-HP	18" High Flow, 27-45 GPM	1,810 lbs	2,450-5,000
160230	24" High Flow, 24-45 GPM	1,970 lbs	2,000-3,500
160230-HP	24" High Flow, 27-45 GPM	1,980 lbs	2,450-5,000
160235	30" High Flow, 30-45 GPM	2,155 lbs	2,500-3,500
160235-HP	30" High Flow, 30-45 GPM	2,160 lbs	2,500-5,000
160240	40" High Flow, 30-45 GPM	2,450 lbs	3,000-3,500
160240-HP	40" High Flow, 30 45 GPM	2,455 lbs	3,000-5,000
160245	48" High Flow, 30-45 GPM	2,685 lbs	3,000-3,500
160245-HP	48" High Flow, 30-45 GPM	3,210 lbs	3,250-5,000
160613	Water Kit for 16"	156 lbs	—
160615	Water Kit for 18"	156 lbs	—
160620	Water Kit for 24"	157 lbs	—
160625	Water Kit for 30"	157 lbs	—
160630	Water Kit for 40"	158 lbs	—
160635	Water Kit for 48"	158 lbs	—

FEATURES INCLUDE

- 12" to 48" grinding widths
- 6" cutting depth
- Electronic adjustment controls
- High-torque, planetary drive
- High drum weight equals less vibration
- Largest drum access in the industry
- 5/8" thick drum tube
- Water kit available
- Fine-cut drum available
- 1-year warranty
- Made in the USA

COLD PLANER SEVERE DUTY



FEATURES INCLUDE

- 18" to 48" grinding widths
- Up to 8" cutting depth
- Hydraulic adjustment controls
- Hydraulic side shift
- High-torque, planetary drive
- High drum weight equals less vibration
- Largest drum access in the industry
- 1 1/2" thick drum tube
- Water kit available
- Fine-cut drum available
- 1-year warranty
- Made in the USA



PART NUMBER	MODEL	WEIGHT	MIN FLOW	MIN PSI
160810	18" Cold Planer, High Flow	1,990 lbs	24 GPM	2,000
160815	24" Cold Planer, High Flow	2,300 lbs	27 GPM	2,000
160820	30" Cold Planer, High Flow	2,770 lbs	30 GPM	2,500
160825	40" Cold Planer, High Flow	2,975 lbs	30 GPM	3,000
160830	48" Cold Planer, High Flow	3,205 lbs	30 GPM	3,450
160615	Water Kit for 18"	155 lbs	—	—
160620	Water Kit for 24"	156 lbs	—	—
160625	Water Kit for 30"	157 lbs	—	—
160630	Water Kit for 40"	158 lbs	—	—
160635	Water Kit for 48"	159 lbs	—	—

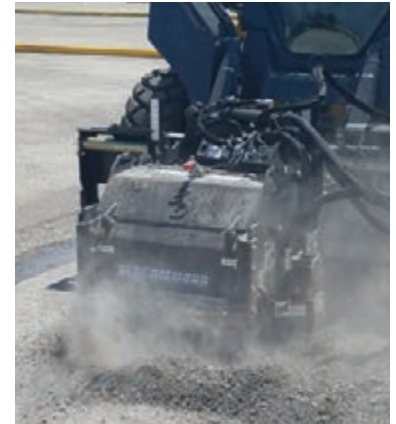

APPLICATIONS INCLUDE:

- Removing asphalt surfaces prior to overlay
- Widening shoulders
- Repairing potholes
- Restoring drainage near curb lines and catch basins
- Mixing stabilizing agents into base for more durable repair

LOW FLOW

FEATURES INCLUDE

- Manual adjustment controls
- Hydraulic side shift
- Direct Drive
- High drum weight equals less vibration
- 5/8" thick drum tube
- Easy access tooth replacement
- Water kit available
- Fine-cut drum available
- 12" - 16" Grinding widths
- Up to 5" Cutting depth



PART NUMBER	MODEL	WEIGHT	MIN FLOW	MIN PSI
160105	12" Low Flow	1,220 lbs	15 GPM	2,000
160110	16" Low Flow	1,250 lbs	15 GPM	2,000
160501	Coupler Kit For Low Flow	3 lbs	—	—
160610	Water Kit For 12"	154 lbs	—	—
160613	Water Kit For 16"	155 lbs	—	—

DISC MULCHER

The Blue Diamond® Skid Steer Disc Mulcher is the most capable disc mulcher the market has to offer. Available in 44" and 60" cutting widths, it has chipping teeth that can rotated 4 times to lengthen their usable life before needing to be sharpened.

PART NUMBER	MODEL	MOTOR	BEST FLOW	WEIGHT
103305	44" Disc Mulcher	100 CC	20-30 GPM	1,725 lbs
103307	44" Disc Mulcher	150 CC	30-44 GPM	1,725 lbs
103310	60" Disc Mulcher	150 CC	32-45 GPM	2,450 lbs
103312	60" Disc Mulcher	200 CC	45-60 GPM	2,450 lbs

FEATURES INCLUDE

- Available in 44" and 60" widths
- 3/8" thick deck and reinforced sides
- Teeth on top, side, and bottom of carrier
- 1" thick hinged deflector
- Throws material away from the machine
- Can cut below ground surface



DRUM MULCHER

The Blue Diamond® Drum Mulcher is designed for clearing brush and heavy mulching. With a 60" cutting width and 34-tooth cutting drum, our mulcher knows no equal. From clearing acres of dense trees to site preparation, no job is too big or too small for your skid steer and the Blue Diamond® Drum Mulcher. Our mulcher uses cutting drum bearings and an overhung load adapter. The head can be configured to be installed on either a closed-loop or open-loop hydraulic system, providing versatility based on the machine you operate and the unique mulcher body design. This also allows for debris to be shed in minimal accumulations.

PART NUMBER	MODEL	BEST FLOW	WEIGHT
190110	60" W/Chipping Teeth	35-52 GPM	2,460 lbs
390115	60" W/Carbide Teeth	35-52 GPM	2,504 lbs

FEATURES INCLUDE

- Low-profile tooth anvil (carbide compatible)
- Heavy duty overhung load adapter
- Hydraulic motor case overpressure protection (COP)
- Heavy duty synchronous drive belt
- Serrated push bar
- Optional gate
- Long-life heavy duty drum bearings
- Single 1" high-grade bolt tooth-fastening system
- Reversible chipping tooth (4 times for chipping tooth, 2 times for carbide tooth)
- Tooth anvil with secondary edge guard
- Danfoss H1B 110 cc 2-speed motor



FORK

GRAPPLE FORK - MAT & SEVERE DUTY

The Blue Diamond® Grapple Fork is a great attachment for carrying everything from pipes and logs to pallets. The adjustable cylinder mount point allows the grapple to open wider or close tighter depending on your needs.



GRAPPLE FORK

FEATURES INCLUDE

- 4-position top clamps
- 48", 60", 72", 84", and 96" tines available
- 45" wide
- 3-position top clamp with adjustments
- Hoses and couplers included
- Fits Class 2 fork tines



MAT GRAPPLE

FEATURES INCLUDE

- Designed for equipment mats
- 42", 48", 60", and 84" tines available
- Special top clamp that holds mats
- 4-position top clamp
- Teeth on grapple that grip mats
- 4,000 lbs capacity
- Fits Class 2 fork tines
- Tines do not adjust



SEVERE DUTY GRAPPLE FORK

FEATURES INCLUDE

- 10,000 lb capacity
- Fits class 3 tines*
- 48", 60", 72", 84", and 96" length tines available
- 45" wide
- 4-position top-clamp
- 3-position tine width adjustment
- Weighs 850 lbs plus tines

PART NUMBER	MODEL	TINE SIZE	WEIGHT
106009	Grapple Fork, Frame ONLY (Select Tines)	—	426 lbs
106010	Grapple Fork, 60" Wide Frame ONLY (Select Tines)	—	633 lbs
106003	Mat Grapple Without Tines	—	936 lbs
306017	Mat Grapple with 48" Tines	48" X 1 3/4"	950 lbs
306016	Mat Grapple with 60" Tines	60" X 1 3/4"	715 lbs
306015	Mat Grapple with 72" Tines	72" X 1 3/4"	936 lbs
306014	Mat Grapple with 84" Tines	84" X 1 3/4"	954 lbs
106012	Grapple Fork, Severe Duty, 10,000 Lbs (Tines Not Included) Fits Class 3	—	850 lbs
106016	Mat Grapple, Severe Duty, 10,000 Lbs (Tines Not Included) Fits Class 3	—	509 lbs

FORK NURSERY

The Blue Diamond® Severe Duty Nursery Fork was designed for the operator who handles trees, bushes, and more. The attachment comes ready to use and includes hoses, couplers, and a protective foam sleeve to cradle the tree trunk. The hoses can be routed to the left or right side to best fit where your machine couplers are. The hose protector spring prevents the hose from getting pinched in between the mount and machine. All pivots have grease fittings and can be accessed without removing any panels.



SEVERE DUTY



PART NUMBER	MODEL	LIFT CAPACITY	WEIGHT
114092	Hydraulic Nursery Fork, Standard Duty	2,500	442 lbs
114095	Hydraulic Nursery Fork, Severe Duty	3,000	693 lbs

PALLET FORK - HYDRAULIC



PART NUMBER	MODEL	TINE SIZE	LIFT CAPACITY	WEIGHT
114045	Pallet Fork, Hydraulic	48"	4,000 LBS	419 lbs
114047	Pallet Fork, Hydraulic	60"	4,000 LBS	460 lbs
114050-2	Pallet Fork, Hydraulic	48"	6,000 LBS	624 lbs
114055-2	Pallet Fork, Hydraulic	60"	6,000 LBS	672 lbs
114057-2	Pallet Fork, Hydraulic	72"	6,000 LBS	700 lbs



HEAVY DUTY



SEVERE DUTY

PALLET FORK - LIGHT & STANDARD DUTY

PART NUMBER	MODEL	TINE SIZE	LIFT CAPACITY	WEIGHT
314003	Pallet Fork, Light Duty	42" X 1 1/4"	2,000 LBS	322 lbs
314061	Pallet Fork, Light Duty	36" X 1 1/2"	2,000 LBS	295 lbs
314060	Pallet Fork, Light Duty	48" X 1 1/2"	2,000 LBS	371 lbs
314006	Pallet Fork Standard, W/Steps	42" X 1 1/4"	3,700 LBS	311 lbs
314007	Pallet Fork Standard	42" X 1 1/4"	3,700 LBS	318 lbs
314004	Pallet Fork, Standard, W/Steps	48" X 1 1/2"	4,000 LBS	375 lbs
314070	Pallet Fork Standard, W/Steps	60" X 1 1/2"	4,000 LBS	413 lbs
314075	Pallet Fork Standard, W/Steps	72" X 1 3/4"	4,000 LBS	493 lbs



PALLET FORK - HEAVY DUTY



PART NUMBER	MODEL	TINE SIZE	LIFT CAPACITY	WEIGHT
314011	Pallet Fork, HD, W/Steps	48" X 1 1/2"	5,000 LBS	375 lbs
314012	Pallet Fork, HD, No Steps	48" X 1 3/4"	5,000 LBS	375 lbs
314013	Pallet Fork, HD, W/Steps	48" X 1 3/4"	5,000 LBS	375 lbs
314014	Pallet Fork, HD, W/Steps	60" X 1 3/4"	5,000 LBS	452 lbs
314085	Pallet Fork, HD, W/Steps	60" X 1 1/2"	5,000 LBS	420 lbs
314090	Pallet Fork, HD, W/Steps	72" X 1 3/4"	5,000 LBS	500 lbs



PALLET FORK - WALK THROUGH STYLE



PART NUMBER	MODEL	TINE SIZE	LIFT CAPACITY	WEIGHT
314009	4200 lb Walkthrough with 48" Tines	48" X 1 1/2"	4,200 lbs	369 lbs
314100	4200 lb Walkthrough with 60" Tines	60" X 1 1/2"	4,200 lbs	411 lbs
314008	5000 lb Walkthrough with 48" Tines	48" X 1 1/2"	5,000 lbs	418 lbs
314110	5000 lb Walkthrough with 60" Tines	60" X 1 1/2"	5,000 lbs	422 lbs
314115	5000 lb Walkthrough with 72" Tines	72" X 1 3/4"	5,000 lbs	450 lbs



PALLET FORK - EXTRA LARGE, HEAVY DUTY

Our Extra Large, Heavy Duty Pallet Forks are rated for 6,000 lbs lift. Using an easy-to-see-through oversized frame, this heavy duty pallet fork provides added lift capacity for larger skid steers. The heavily reinforced brick guard and quick attach area make it extremely durable for heavy use. 48" x 1 3/4" tines are standard, and 60" and 72" are available. These pallet forks feature a extra wide and tall frame, and they are serial numbered with lifting capacities in lb. and kg. to meet job site requirement for lifting equipment.



FEATURES INCLUDE

- 3" heavily reinforced carriage bar
- 51" wide frame
- 44" Tall frame
- 6,000 lb. capacity
- Side steps standard

PART NUMBER	MODEL	TINE SIZE	LIFT CAPACITY	WEIGHT
314015	Pallet Fork, Extra Large HD	48" X 1 3/4"	6,000 lbs	500 lbs
314016	Pallet Fork, Extra Large HD	60" X 1 3/4"	6,000 lbs	500 lbs
314017	Pallet Fork, Extra Large HD	72" X 1 3/4"	6,000 lbs	591 lbs



FORK

PALLET FORK - TALL FRAME, HEAVY DUTY D-RING

PART NUMBER	MODEL	TINE SIZE	LIFT CAPACITY	WEIGHT
314019	Pallet Fork, HD, W/Steps/D-Ring	48" X 1 3/4"	6,000 LBS	375 lbs
314020	Pallet Fork, HD, W/Steps/D-Ring	48" X 1 1/2"	5,500 LBS	486 lbs
314021	Pallet Fork, HD, W/Steps/D-Ring	60" X 1 3/4"	6,000 LBS	560 lbs
314022	Pallet Fork, HD, W/Steps/D-Ring	60" X 1 1/2"	5,500 LBS	260 lbs
314023	Pallet Fork, HD, W/Steps/D-Ring	72" X 1 3/4"	6,000 LBS	562 lbs
314024	Pallet Fork, HD, W/Steps/D-Ring	42" X 1 3/4"	6,000 LBS	481 lbs



PALLET FORK - CLASS 3, 10,000 LBS.

PART NUMBER	MODEL	TINE SIZE	LIFT CAPACITY	WEIGHT
314150	Frame	48" X 1 3/4"	10,000 lbs	595 lbs
314152	Frame	60" X 1 3/4"	10,000 lbs	732 lbs
314155	Frame	60" X 2"	10,000 lbs	758 lbs
314160	Frame	72" X 2"	10,000 lbs	828 lbs
314165	Frame	84" X 2"	10,000 lbs	848 lbs
314167	Frame	96" X 2"	10,000 lbs	875 lbs



PALLET FORK - WIDE FRAME, HEAVY DUTY

PART NUMBER	MODEL	TINE SIZE	LIFT CAPACITY	WEIGHT
314025	Pallet Fork W/Backrest	72" X 1 3/4"	5,500 LBS	738 lbs
314027	Pallet Fork W/Backrest	60" X 1 3/4"	5,500 LBS	690 lbs
314028	Pallet Fork	60" X 1 3/4"	5,500 LBS	738 lbs
314029	Pallet Fork	72" X 1 3/4"	5,500 LBS	1,080 lbs



PALLET FORK - BLOCK & BRICK, HEAVY DUTY

PART NUMBER	MODEL	TINE SIZE	LIFT CAPACITY	WEIGHT
114175	42" Tine STD Class 2	42" x 2" x 1 1/2"	3,600 - 4,800 lbs	64 lbs
114178	48" Tine STD Class 2	48" x 2" x 1 1/2"	3,600 - 4,800 lbs	75 lbs
114185	42" Tine STD Class 2	42" x 2" x 2"	3,600 - 4,800 lbs	64 lbs
114180	48" Tine STD Class 2	48" x 2" x 2"	3,600 - 4,800 lbs	75 lbs



Tine only.

GRAPPLES

BUCKET - LIGHT DUTY

The Blue Diamond® Light Duty Grapple Bucket is designed for small loaders with limited lift capacity. Weighing less than 500 lbs, it eliminates the worry of tipping the machine. Dual top clamps and grease fittings are standard. These lightweight grapples are suited for machines with lifting capacity of 1,500 lbs or less.



PART NUMBER	MODEL	LIFT CAPACITY	WEIGHT
106065	66" Grapple Bucket, Light Duty, Dual Clamps	11.07 CU FT	480 lbs

BUCKET - HEAVY DUTY

The Blue Diamond® Heavy Duty Grapple Bucket is designed for machines up to 50 hp with a moderate workload. Made from 1/2" steel, it is strong yet light enough for smaller machines. Pivot-point grease fittings and couplers are standard. Available in 60", 66", and 72" widths with excellent visibility.



PART NUMBER	MODEL	LIFT CAPACITY	WEIGHT
106077	60" Grapple Bucket, HD, Dual Clamps	10.26 CU FT	740 lbs
106085	66" Grapple Bucket, HD, Dual Clamps	11.07 CU FT	587 lbs
106095	72" Grapple Bucket, HD, Dual Clamps	11.88 CU FT	613 lbs

BUCKET - SEVERE DUTY

The rugged Blue Diamond® Severe Duty Grapple Bucket comes from years of input from demolition contractors and recyclers. The severe duty model combines features from our previous demolition series, our extreme duty model, and some new features to put it among the most effective and durable grapple buckets in the industry. The operator can use the bolt-on sides to contain more material or can remove the sides for handling longer products like pipe or trees. The pivot points are designed for the heavy continuous use seen in large recycling and scrap metal facilities. The pivot pins are 1 1/4" diameter and are housed in bushings with grease fittings. The upper clamps use 2 heavy gauge crossmembers, and a solid plate protects the bottom of the cylinder. The no-pinch hose routing helps to prevent downtime from crushed hoses.



PART NUMBER	MODEL	LIFT CAPACITY	WEIGHT
106429	60" Grapple Bucket, Severe Duty	10.26 CU FT	905 lbs
106444	66" Grapple Bucket, Severe Duty	11.07 CU FT	1,139 lbs
106454	72" Grapple Bucket, Severe Duty	11.88 CU FT	1,179 lbs
106457	72" Grapple Bucket, Severe Duty W/Teeth	11.88 CU FT	1,066 lbs
106464	78" Grapple Bucket, Severe Duty	12.69 CU FT	1,210 lbs
106476	84" Grapple Bucket, Severe Duty	14.00 CU FT	1,227 lbs

GRAPPLES ROCK BUCKET

The Blue Diamond® Standard & Heavy Duty Rock Bucket/Grapple uses 3/8" steel with the tines spaced at 3" apart. This very popular bucket can be used for sifting or raking and is available with dual grapples for holding your load. Works well as a land plane, skimming off high spots with the leading edge and smoothing the loose soil with the rear crossbar. The drop down inside keeps rocks from sliding out.

FEATURES INCLUDE

- Laser-cut cutting edge gussets on tips of tines
- 3" spacing between tines
- 3 styles of grapples available
- Works great as a land plane and for light clearing



STANDARD DUTY



HEAVY DUTY

PART NUMBER	MODEL	WEIGHT
108319	60" Rock Bucket, W/Standard Grapple	582 lbs
108325	66" Rock Bucket, W/Standard Grapple	608 lbs
108340	72" Rock Bucket, W/Standard Grapple	633 lbs
108330	66" Rock Bucket, W/Heavy Duty Grapple	689 lbs
108345	72" Rock Bucket, W/Heavy Duty Grapple	740 lbs
108360	78" Rock Bucket, W/Heavy Duty Grapple	764 lbs
108380	84" Rock Bucket, W/Heavy Duty Grapple	787 lbs

ROCK BUCKET - SEVERE DUTY

The Blue Diamond® Severe Duty Rock Bucket/Grapple offers true versatility! The bolt-on sides help when rock picking and sifting but can be removed for carrying logs and brush. The angled and scalloped edge excels at leveling and raking.

FEATURES INCLUDE

- No-pinch hose routing for grapple
- Back is open on either side of quick attach for better sifting
- New style of cutting edge for better leveling
- Increased structure in top clamps to prevent twisting
- 1/2" bucket tines



SEVERE DUTY

PART NUMBER	MODEL	WEIGHT
108450	72" Rock Bucket, Severe Duty W/Grapple	1,096 lbs
108455	78" Rock Bucket, Severe Duty W/Grapple	1,142 lbs
108460	84" Rock Bucket, Severe Duty W/Grapple	1,194 lbs

GRAPPLES RAKE - HEAVY DUTY

The Blue Diamond® Heavy Duty Grapple Rake for skid steers is a great alternative to a root grapple when visibility is important. This grapple rake features a single top clamp and 1/2" tines. It fully opens to 52"



HEAVY DUTY

FEATURES INCLUDE

- Single top clamp
- Opens to 52"
- 1/2" tine width

PART NUMBER	MODEL	WEIGHT
107001	63" Grapple, Rake, HD, Single Clamp	689 lbs
107005	72" Grapple, Rake, HD, Single Clamp	740 lbs
107010	80" Grapple, Rake, HD, Single Clamp	770 lbs
107015	84" Grapple, Rake, HD, Single Clamp	955 lbs



RAKE - SEVERE DUTY

The Blue Diamond® Severe Duty Grapple Rake for skid steers is built to tackle the most demanding projects. The attachment comes with 3/4" tines, replaceable teeth, and dual top clamps.



SEVERE DUTY

FEATURES INCLUDE

- Dual top clamps
- 3/4" tine width
- Replaceable teeth

PART NUMBER	MODEL	WEIGHT
106515	72" Grapple, Rake, SD, Dual Clamp	1,256 lbs
106520	78" Grapple, Rake, SD, Dual Clamp	1,269 lbs
106525	84" Grapple, Rake, SD, Dual Clamp	1,350 lbs



GRAPPLES

ROOT - LIGHT DUTY

The Blue Diamond® Light Duty Root Grapple is designed with small skid steers in mind with limited lift capacity. Weighing only 454 lbs, this attachment lets you grab a load without the fear of tipping your machine. Dual top clamps and grease fittings are standard.



PART NUMBER	MODEL	WEIGHT
106053-S	48" Grapple, Root, Light Duty, Single Clamp	350 LBS
106054-S	52" Grapple, Root, Light Duty, Single Clamp	365 LBS
106053	48" Grapple, Root, Light Duty, Dual Clamps	399 LBS
106054	52" Grapple, Root, Light Duty, Dual Clamps	407 LBS
106057	56" Grapple, Root, Light Duty, Dual Clamps	425 LBS
106055	60" Grapple, Root, Light Duty, Dual Clamps	440 LBS
106060	66" Grapple, Root, Light Duty, Dual Clamps	689 LBS

FEATURES INCLUDE

- 3/8" Tines
- Dual or Single Top Clamps
- Greasable Pivot Pins
- Universal Mount
- 3"x3" Tube
- 1" Pivot Pins
- Includes hoses and couplers
- 1,500 lb lifting capacity

ROOT - HEAVY DUTY

The Blue Diamond® Heavy Duty Root Grapple is designed for up to 50 hp machines with a moderate work load. Made from 1/2" steel, this attachment is strong yet light enough for smaller machines such as skid steers. Pivot-point grease fittings and couplers are standard.



PART NUMBER	MODEL	WEIGHT
106075	60" Grapple, Root, HD, Dual Clamps	608 lbs
106080	66" Grapple, Root, HD, Dual Clamps	633 lbs
106090	72" Grapple, Root, HD, Dual Clamps	689 lbs

For machines with up to 50 HP

FEATURES INCLUDE

- 1/2" thick top clamps
- Cylinder protection covers
- Opens to 32"
- Best suited for machines up to 50hp or 1800 lb lift capacity
- Protected hoses

ROOT - SEVERE DUTY

This Blue Diamond® Severe Duty Root Grapple has a number of improved features that take it a step above the extreme design. An enclosed back, heavier top clamps, 1-piece tines, and hose routing are all improvements to reinforce areas that are prone to damage from heavy use. In addition, extra long tubing in the top clamp prevents twisting.



PART NUMBER	MODEL	WEIGHT
106440	66" Grapple, Root, Severe Duty	608 lbs
106450	72" Grapple, Root, Severe Duty	633 lbs
106460	78" Grapple, Root, Severe Duty	689 lbs
106470	84" Grapple, Root, Severe Duty	740 lbs

FEATURES INCLUDE

- 1/2" thick tines
- Closed-in quick-attach area
- Reinforced top clamps
- Hoses exit left cylinder tower to prevent pinching

GRAPPLES

ROOT - EXTREME DUTY, HIGH CAPACITY

This Blue Diamond® Extreme Duty, High Capacity Root Grapple is designed to handle very large jobs with ease. The protected cylinders and hoses ensure that down time is kept to a minimum. From the heavily reinforced mount to the rugged top clamps, this grapple is one of the toughest on the market. The massive top clamps allow for 25" x 42" worth of material to be grabbed in each load.



PART NUMBER	MODEL	WEIGHT
106220	72" Grapple, Root, Extreme Duty, High Capacity	1,159 lbs
106230	78" Grapple, Root, Extreme Duty, High Capacity	1,194 lbs
106240	84" Grapple, Root, Extreme Duty, High Capacity	1,294 lbs
106260	96" Grapple, Root, Extreme Duty, High Capacity	1,360 lbs

FEATURES INCLUDE

- 3/8" thick tines with 1/2" top clamps
- 25" x 42" opening inside of clamps
- Opens to 59" at tip of tines/clamp
- Dual acting cylinders
- Heavily reinforced mount
- Serrated tine tips to rip through roots





HAY ACCUMULATOR

PART NUMBER	MODEL	WEIGHT
111405	Hay Accumulator Grapple, Fit 8-10 SQ Bales	785 lbs

Holds up to 10 square bales



HAY SPEARS

Blue Diamond® offers a very high quality yet compact Hay Spear. It is available in three styles: a single spear with standard or heavy duty stabilizers for round bales, a double bottom, or a quad bottom style for large square bales which can also be used as a pallet fork. The high quality German-made spear tines are rated for 3,500 lbs each, and the lower stabilizers are replaceable. These strong frames are powder coated, and a bolt-on back rack is available.

All of our hay spears carry a 1-year warranty, with a 2-year warranty on tines.



SINGLE SPEAR



DOUBLE BOTTOM SPEAR



QUAD BOTTOM SPEAR



OPTIONAL BOLT-ON RACK
SHOWN ON DOUBLE BOTTOM

PART NUMBER	MODEL	SPEAR LENGTH	WEIGHT
311003	Hay Spear W/ HD Stabilizers (Short Spear)	36"	154 lbs
311006	Hay Spear W/Standard Stabilizers	48"	160 lbs
311007	Hay Spear W/Standard Stabilizers & Back Rack	48"	204 lbs
311008	Hay Spear W/ HD Stabilizers	48"	165 lbs
311009	Double Bottom Hay Spear (Short Spears)	36"	180 lbs
311010	Double Bottom Hay Spear	48"	190 lbs
311011	Double Bottom Hay Spear W/Rack	48"	218 lbs
311040	Double Top Tine Hay Spear W/Bottom Stabilizers	48"	190 lbs
311045	Quad Bottom Hay Spear, 45" Wide	48"	262 lbs
311050	Quad Bottom Hay Spear, 60" Wide	48"	280 lbs
311060	Quad Bottom Hay Spear, 75" Wide	48"	304 lbs

LAND PLANE



The Blue Diamond® Land Plane, also known as a land leveler, is a very useful tool for doing fine leveling and site preparation. Cut, grade, and level faster with this bidirectional attachment.

FEATURES INCLUDE

- Excellent grading tool for leveling dirt and gravel
- Works in forward or reverse
- Multiple cutting edges
- Great sod removal capabilities

PART NUMBER	MODEL	WEIGHT
115040	72" Land Plane	350 lbs
115060	84" Land Plane	450 lbs



LOG GRAPPLE

The Blue Diamond Rotating® Log Grapple is a high quality attachment for tree work. Whether you are working in the log yard or clearing land, this tool can handle the load. The serrated brace helps stabilize logs when moving. The impressive clamping force tightly holds onto large logs. Two models are offered: 180° manual rotation and 360° hydraulic rotation.

FEATURES INCLUDE

- 2,500 lb capacity
- Serrated quick attach for load stabilization
- HD welded cylinder
- Serrated boom to stabilize and push
- Rope tie / chain tie off attach point
- Closes up to 5 inches
- Opens to 62 inches

PART NUMBER	MODEL	WEIGHT
106815	Manual Rotation	500 lbs
106820	Hydraulic Rotation	550 lbs

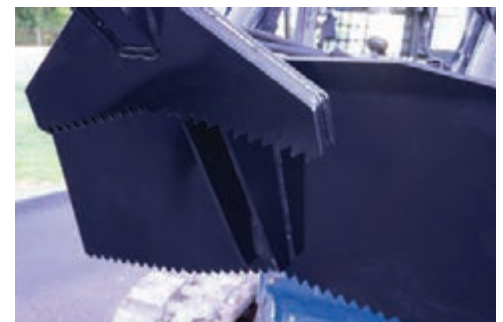

LOAD STABILIZATION BASE

LOG SPLITTER 25-TON

The Blue Diamond® 25-Ton Traditional Log Splitter can be used horizontally or vertically. The powerful cylinder is controlled by a single easy-to-use lever. It can handle up to a 24" long log with ease.

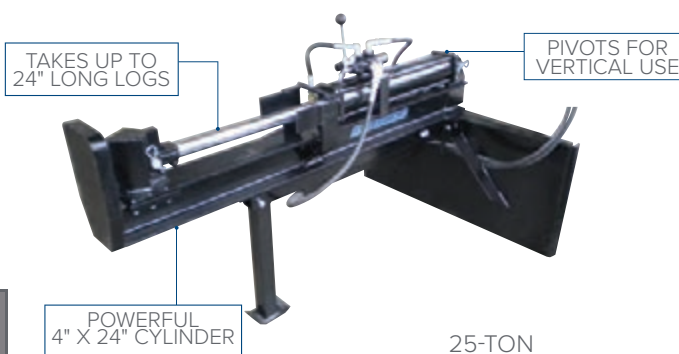

PART NUMBER	MODEL	WEIGHT
150000	25-Ton Log Splitter, Traditional	475 lbs

35-TON

The Blue Diamond® 35-Ton Inverted Log Splitter takes firewood production to the next level. With the optional 4-way wedge and the 35-ton cylinder, you can split incredible amounts of wood from the comfort of your cab!



- FEATURES INCLUDE**
- 2- or 4-way wedge available
 - Protected 35-ton cylinder
 - Heavy duty sliders
 - Opens to 30"
 - 1-year warranty

PART NUMBER	MODEL	WEIGHT
150015	35-Ton Log Splitter, Inverted (Req Wedge)	450 lbs
150017	Single Wedge For 35-Ton Inverted	85 lbs
150018	4-Way Wedge For 35-Ton Inverted	105 lbs



MATERIAL ROLLER

Your workday just got a lot easier, introducing the Blue Diamond® Material Roller. Precisely crafted and ruggedly built, the material roller will not only lighten your load, but cut your crew requirements by almost half. From loading and unloading the flat-bed to laying down roll after roll, any project will get done faster with less physical effort with the material roller.

PART NUMBER	MODEL	WEIGHT
174005	Material Roller, Hydraulic Side Angle (Requires Stem)	500 lbs
174105	3 1/2" Dia, Roll Stem for 4' Wide Roll	40 lbs
174110	3 1/2" Dia, Roll Stem for 6.67' Wide Roll	60 lbs
174115	3 1/2" Dia, Roll Stem for 8' Wide Roll	66 lbs
174120	3 1/2" Dia, Roll Stem for 16' Wide Roll	174 lbs
174130	2 3/8" Dia, Roll Stem for 4' Wide Roll	18 lbs
174135	2 3/8" Dia, Roll Stem for 6.67' Wide Roll	28 lbs
174140	2 3/8" Dia, Roll Stem for 8' Wide Roll	33 lbs



FOLDS UP FOR STORAGE AND TRANSPORT

FEATURES INCLUDE

- Hydraulic actuator allows the stem to swing 180° left or right, 115° up, and 8° down
- Detachable stem available in 3 lengths
- Retaining collar with quick pin keeps material perfectly positioned on the stem

MATERIAL SPREADER

The Blue Diamond® Heavy Duty Material Spreader is the most efficient way to spread material! Simply use the hopper like a bucket to scoop your material then turn on the hydraulics to spread up to 30' wide.



FEATURES INCLUDE

- Available in 8 and 18 cu. ft. capacity
- Spreads up to 30' wide
- Self-loading: scoop material into the hopper
- Hardened Steel cutting edge
- Protective Grate to prevent clogging
- Adjustable flow with a manually operated gate
- Steel spreader with replaceable paddles
- Steel agitator to keep material flowing smoothly
- Optional sidewalk deflector



PART NUMBER	MODEL	WEIGHT
101055	Spreader, Standard Duty, 5 Cu/Ft	95 lbs
101060	Receiver 2, Heavy Duty (For Standard Duty)	10 lbs
101065	Salt Spreader, Vibrator Kit (For Standard Duty)	9 lbs
101070	Gate Kit Spreader, Free Flowing (For Standard Duty)	8 lbs
101110	Spreader, Heavy Duty, 8 Cu/Ft	415 lbs
101115	Spreader, Heavy Duty, 18 Cu/Ft	635 lbs
101155	Sidewalk Deflector Kit For Heavy Duty	27 lbs

MOUNT PLATE

Make your own attachment or make your old attachments fit your new skid steer. Mounts available to fit to all universal hitch machines, John Deere 400/500, and Euro-AG. Made from 1/4" or 1/2" thick solid plate.



UNIVERSAL SKID STEER MOUNT

PART NUMBER	MOUNT	THICKNESS	WEIGHT
113005	Universal Skid Steer	1/4"	75 lbs
113005-14	JD 400/500	1/4"	54 lbs
113005-16	Euro-AG	1/4"	55 lbs
113006	Universal Skid Steer	1/2"	140 lbs

POST DRIVER VIBRATORY SERIES 2

The Blue Diamond® Vibratory Series 2 Post Driver is the best post driver for full-size skid steers, mini skid steers, and excavators, ideal for both commercial and for rental fleet use! Useful for many industries, a vibratory post driver makes the job faster and more efficient for works in construction, agriculture, solar installation, and more!



PART NUMBER	MODEL	WEIGHT
100502	Post Driver, Vibratory S2 (Requires Mount)	264 lbs
100507	Post Driver, Vibratory, W/Tilt (Requires Mount)	400 lbs
100510	Vibratory Tilt Option	123 lbs
100555	Skid Steer Mount	125 lbs
100516	4" Round Post Adapter	15 lbs
100521	6" Round Post Adapter	17 lbs
100526	9" Round Post Adapter	19 lbs
100528	10" Round Post Adapter	37 lbs
100531	12" Round Post Adapter	50 lbs
100552	12" Square Flat Post Adapter	41 lbs
100553	12" Round Flat Post Adapter	35 lbs

FEATURES INCLUDE

- Optional tilt function allows for 10 degrees of adjustment
- Hydraulic orbital technology maximizes auxiliary flow
- Available with 4" - 12" round and flat post adapters
- Compact design that is easy to transport and store
- Requires 7-26 GPM auxiliary flow and case drain
- OEM and universal wiring harnesses available
- Easily swap between machines with the interchangeable mount



POWER RAKE HEAVY DUTY SERIES 2

This Heavy Duty Series 2 Power Rake follows close on the heels of our previously released Severe Duty model. This lighter unit is suited to smaller frame skid steers and walk behind machines. The bolt-on mount allows greater flexibility for rental companies and dealers to have the correct model for the right machine, with mounts offered for mini and full size skid steer machines.



SHOWN WITH FIXED TEETH OPTION



REVERSIBLE SIDE SHIELD



FLIP UP WHEELS



HYDRAULIC ANGLE KIT SHOWN ATTACHED



HEAVY DUTY PROTECTED BEARING

PART NUMBER	MODEL	WEIGHT
132407	48" Power Rake, HD2, Replaceable Teeth	528 lbs
132408	60" Power Rake, HD2, Replaceable Teeth	580 lbs
132409	72" Power Rake, HD2, Replaceable Teeth	600 lbs
132400	48" Power Rake, HD2, Fixed Teeth	526 lbs
132401	60" Power Rake, HD2, Fixed Teeth	584 lbs
132402	72" Power Rake, HD2, Fixed Teeth	714 lbs
132404	Skid Steer Mount, Heavy Duty Series 2	159 lbs
132406	HD2 Hose Kit For Manual Angle	10 lbs
132410	HD2 Hose Kit For Manual Angle 78" Hoses	15 lbs
232469	HD2 Hydraulic Angle Hoses 85" Oal	9 lbs

Select base model, mount and hydraulic kit. You can get harden steel or carbide teeth that are either replaceable or fixed.

SEVERE DUTY SERIES 3

The Blue Diamond® Severe Duty Series 3 Power Rake is a must-have for anyone who uses a power rake for a living. This unit is the biggest and strongest power rake that we offer, and an industry leader for durability and ease of maintenance. It comes standard with the airless tires you've come to love, and the increased drum diameter moves soil faster than ever before.



PART NUMBER	MODEL	WEIGHT
132515	84" Power Rake, Replaceable Teeth	1,225 lbs
132520	96" Power Rake, Replaceable Teeth	1,275 lbs
132055	Case Drain Line 84" Cut Length	2 lbs
132056	Case Drain Line 156" Cut Length For 96" & 120"	5 lbs
132525	108" Power Rake, Replaceable Teeth	1,385 lbs
132530	120" Power Rake, Replaceable Teeth	1,366 lbs

You can get harden steel or carbide teeth that are either replaceable or fixed.



POWER RAKE EXTREME DUTY



When productivity matters, look no further. Travel faster, cut deeper, and get on to the next job! With skid steer machine sizes increasing in the industry, there is a need for a more powerful and durable power rake/soil conditioner attachment. The Blue Diamond® Extreme Duty Power Rake is designed to power through jobs where others fail and is set up for simple servicing. This massive 6000 series motor and optimal drum size produce maximum torque, and the motor is kept out of the way, maximizing usable width in tighter areas. Aggressive 2” teeth are ideal for leaving a fresh seed bed with fewer passes.



PART NUMBER	MODEL	WEIGHT
132126	48" Power Rake, Replaceable Teeth (W/Skid Steer Mount)	590 lbs
132110	72" Power Rake, Replaceable Teeth	1,136 lbs
132115	84" Power Rake, Replaceable Teeth	1,160 lbs
132120	96" Power Rake, Replaceable Teeth	1,185 lbs
132125	48" Power Rake, Fixed Teeth (W/Skid Steer Mount)	590 lbs
132112	72" Power Rake, Fixed Teeth	1,085 lbs
132117	84" Power Rake, Fixed Teeth	1,110 lbs
132122	96" Power Rake, Fixed Teeth	1,135 lbs
332520	Hydraulic Angle Kit, Fits 72-84" (Universal Harness Included, OEM Connection Sold Separately)	51 lbs
332525	Hydraulic Angle Kit, Fits 96" (Universal harness included, OEM connection sold separately)	52 lbs
132065	Power Rake Manual Angle Kit, Fits 72-96"	20 lbs
132066	Power Rake Manual Angle Kit, Fits 120"	25 lbs
132050	Optional Power Rake Skid Shoes	30 lbs
216900	OEM 14-Pin Harness (Specify Machine)	1 lbs
216915	OEM 14-Pin Jd Harness	3 lbs
216905	OEM 8-Pin Cat Harness	3 lbs
216950	OEM 7-Pin Bobcat Harness	1 lbs
200011	OEM Extension Harness	1 lbs

FEATURES INCLUDE

- 6,000 series motor weighs twice what competitive models do, and has around 40% more torque
- 4" x 4" square tube frame
- 18 – 26 GPM hydraulic flow, max 4000 PSI
- Optional replaceable teeth versus fixed teeth that require welding to replace
- 1.5" spindle on castors with spacers versus friction adjusters that work loose
- Airless tires – no flats
- 1" front wheel axles versus competitive ¾"
- 1.5" motor shaft and high pressure seals
- 5 position, 20 degree angle, manual or hydraulic
- Optional bolt-on skid shoes add 30% load capacity over side plates alone
- 6 ¾" drum diameter, 10 ¾" including teeth
- Replaceable teeth hardness is HRC 50
- Double struts on the castors

You can get harden steel or carbide teeth that are either replaceable or fixed.



SIDE PLATE WITH SKID SHOE



AIRLESS TIRES - NO FLATS

POWER RAKE STANDARD DUTY

This lighter unit is suited to smaller frame skid steers and walk behind machines. The bolt-on mount allows greater flexibility for rental companies and dealers to have the correct model for the right machine, with mounts offered for mini and full size skid steer machines.



PART NUMBER	MODEL	WEIGHT*
332450	48" Power Rake With Fixed Mount	550 lbs
332451	48" Power Rake With Manual Angle Mount	600 lbs
332452	48" Power Rake With Hydraulic Angle Mount	625 lbs
332453	60" Power Rake With Fixed Mount	600 lbs
332454	60" Power Rake With Manual Angle Mount	650 lbs
332455	60" Power Rake With Hydraulic Angle Mount	675 lbs
332456	72" Power Rake With Fixed Mount	700 lbs
332457	72" Power Rake With Manual Angle Mount	750 lbs
332458	72" Power Rake With Hydraulic Angle Mount	775 lbs

* — Add -25 for Mini Universal and add -26 for Bobcat MT. ** — Weight varies on mount

FEATURES INCLUDE

- Flip up wheels
- No-flat airless wheels
- Drum width 48", 60", and 72"
- 5/8" greaseable axles on wheels
- 7" diameter drum with 1 1/2" teeth
- Overall width 12" more than drum width
- 1 1/4" spindles with adjustable height
- Bolt-on mount (can be switched for a different mini or full size skid steer mount)
- Spindles on drum are 1 3/8" diameter greaseable bearings
- Fixed carbide teeth
- Available with manual or hydraulic angle

RIPPER

Our Blue Diamond® Ripper is great for penetrating the ground on farms, gardens, and driveways. You can easily prepare a garden or till up a large parcel of land, and it's great for loosening hard-packed ground. The tines on the ripper can be adjusted for more or less ground penetration. Alternate names for the ripper include tiller and field cultivator in the skid steer and related industries. This ripper fits mini and full-sized skid steer machines.



SHOWN WITH OPTIONAL FINISHING RAKE

PART NUMBER	MODEL	WEIGHT
170210	60" Ripper Skid Steer Mount	300 lbs
170215	72" Ripper Skid Steer Mount	405 lbs
170225	84" Ripper Skid Steer Mount	419 lbs
170230	96" Ripper Skid Steer Mount	519 lbs
170310	Optional, Finish Rake 60"	440 lbs
170315	Optional, Finish Rake 72"	487 lbs
170325	Optional, Finish Rake 84"	512 lbs
170330	Optional, Finish Rake 96"	554 lbs

FEATURES INCLUDE

- Adjustable tines
- Available sizes: 60", 72", 84", or 96"
- Optional finishing rake
- 1-year warranty

ROAD SAW

Blue Diamond® high flow road saws offer high rates of production at a substantially lower cost than smaller, self-propelled wheel saws. Our high flow skid steer road saws are offered in cutting depths up to 10- or 18-inches! All feature planetary reduction drives, which efficiently provide maximum cutting torque under load. All saws utilize a ground-engaging frame, which provides accurate depth of cut control. This means the frame is in contact with the ground during the cutting operation, and the cutting wheel moves up and down within this frame, giving the operator the ability to maintain control of the cut.



PART NUMBER	MODEL	WEIGHT
161000	10" Cut Depth, Road Saw (Req Cutting Wheel)	1,196 lbs
161005	18" Cut Depth, Road Saw (Req Cutting Wheel)	1,972 lbs
161505	10" Depth X 2.5"W Cutting Wheel	127 lbs
161510	10" Depth X 4.5"W Cutting Wheel	165 lbs
161530	18" Depth X 3"W Cutting Wheel	372 lbs
161533	18" Depth X 4.5"W Cutting Wheel	426 lbs
161535	18" Depth X 6"W Cutting Wheel	481 lbs

ROCK & CONCRETE GRINDER

The Blue Diamond® Rock & Concrete Grinders are a must have tool for any application where rock, concrete, or asphalt need to be removed. They allow for a clean trench to be made with vertical walls. Four different models are available. When pairing with a skid steer, use the model with the flow that matches the best host machine.



APPLICATIONS:

- Trenching
- Demolition
- Rock Excavation

FEATURES INCLUDE

- All American-made parts & components
- Powerful high torque hydraulic motors
- Robust cutting drums to ensure maximum production & prolonged life
- Customizable drums to accommodate performance maximized applications
- Durable spur gears & housing
- Bolt-on mount for excavator or skid steer

PART NUMBER	MODEL	WEIGHT (WITHOUT MOUNT)	CUTTING WIDTH	HEAD DIAMETER	REQUIRED FLOW (GPM)	CARRIER WEIGHT
159010	G1S	265 lbs	19"	9"	5-12	1,300-5,000 lbs
159015	G1	635 lbs	21"	11"	8-20	6,900-17,000 lbs
159020	G2	1,035 lbs	25"	16.5"	12-26	17,000-30,000 lbs
159025	G3	2,045 lbs	31"	22"	30-45	22,000-39,000 lbs

ROOF TRUSS JIB

The Blue Diamond® Roof Truss Jib is a hydraulically driven pole allows for easy transportation of your items, with the ability to hydraulically extend your height by 72". The pole has a 4" x 4" base with 3/8" thick walls. The manual extension arm can be positioned in 2 different height locations, one at 12" and the other at 24".

FEATURES INCLUDE

- Up to 220" additional reach
- 1,200 lbs capacity retracted, 500 lb extended
- 3" X 3" X 48" hydraulic extension arm
- 2" X 2" X 24" manual extension arm
- 2 1/2" hole for hooking chains and straps
- Ideal for setting roof trusses or beams



PART NUMBER	MODEL	WEIGHT
112105	Roof Truss Jib, Hydraulic Telescopic, 1200 LB Capacity, 220" Long	265 lbs

ROOT RAKE SEVERE DUTY

The Blue Diamond® Severe Duty Root Rake is great for cleaning up your land. The 5 1/4" tine spacing allows you to rake through the dirt and push out rocks, sticks, and other debris.



PART NUMBER	MODEL	WEIGHT
170165	60" Root Rake Severe Duty	235 lbs
170170	66" Root Rake Severe Duty	392 lbs
170175	72" Root Rake Severe Duty	415 lbs
170180	78" Root Rake Severe Duty	453 lbs
170185	84" Root Rake Severe Duty	547 lbs

FEATURES INCLUDE

- Solid 1 piece tines
- 5/8" thick tines
- Reinforced tubing in main frame
- 33" tall

ROTOTILLER



Till 6" or 8" deep with the heavy duty bidirectional Blue Diamond® Rototiller. A heavy front cross-tube keeps the unit floating and strengthens the leading edge. Minimum required 15 GPM. The pivoting tines allow for maximum bite in either direction.

PART NUMBER	MODEL	WEIGHT
129010	68" Rototiller, 6" Depth	490 lbs
129012	68" Rototiller, 8" Depth	590 lbs
129015	76" Rototiller, 6" Depth	630 lbs
129017	76" Rototiller, 8" Depth	630 lbs



SILT FENCE INSTALLER

The Blue Diamond® Silt Fence Installer is essential for erosion control. Easily install silt fencing in a fraction of the time. The design allows a trench to be cut and installs the fence up to 20” deep without needing to pre-trench and backfill. Two models are available to best suit your application; a fixed center mount fits most applications, or a sliding offset mount for installation near buildings or other structures.

FEATURES INCLUDE

- Trench and install fencing in once pass
- 40° pivot to either side of center for turning
- Fits up to 30” diameter roll
- Spring loaded coulter easily cuts through trash, roots and other debris
- Installs up to 20” deep
- Fits 36”, 42”, and 48” tall fencing
- Sliding offset mount allows for installation next to buildings/ structures
- No hydraulics = minimal maintenance
- Install thousands of feet of fencing per hour

PART NUMBER	MODEL	WEIGHT
175015	Silt Fence, W/Center Mount	775 lbs
175020	Silt Fence, W/Side Shift Mount	780 lbs
275110	Silt Fence Fabric Bulk Roll 36”H X 1,500 FT	68 lbs
275108	Silt Fence Fabric 3' (Sold Per Ft, Min 100')	.10 lbs
475015	Silt Fence, W/Center Mount, 3-point hitch	800 lbs
475020	Silt Fence, W/Side Shift Mount, 3-point hitch	800 lbs



CENTER MOUNT MODEL



SIDE SHIFT MODEL

AUTOWING SNOW PLOW

Move more snow with a snow plow that thinks for itself with the Blue Diamond® Autowing Snow Plow. Its mechanical wings automatically adjust from scoop mode to windrow position as you angle the plow allowing multiple angles to add torsional strength and prevent twisting under heavy loads. By combining the ease of straight blade operation with the productivity of a winged snow plow, the Blue Diamond® Autowing Snow Plow clears big jobs fast and ensures quality and consistency on every plow.



FEATURES INCLUDE

- 103" width
- 29" blade height
- Side wings adjust automatically
- Full-trip moldboard
- Steel cutting edge
- Hydraulic angle
- 6° oscillation to follow ground contour



FULL-TRIP MOLDBOARD



FULLY ANGLED BLADE

PART NUMBER	STRAIGHT WIDTH	ANGLED WIDTH	ANGLE	COUPLERS	SIDE MARKERS	CYLINDERS	MOUNT	WEIGHT
120720	103"	93.4°	25°	1/2" Flat Face	Yes	2	Universal Skid Steer	945 lbs
120730	Autowing Skid Steer Mount Assembly (Includes Hoses)						Skid Steer	463 lbs

SNOW BLADE HEAVY DUTY SERIES 2 MULTI-PURPOSE

The Blue Diamond® Heavy Duty Series 2 Multi-Purpose Blade is designed for commercial contractors. At 28" tall, this blade is purpose-built for large applications and has an optional 8" height extension that can be bolted on for even more capacity. The curved back keeps the material rolling for maximum efficiency. Adjustable skid shoes allow the cutting edge to land perfectly every time. The full-trip moldboard protects the operator and equipment from hidden obstacles or curbs. These blades have a trip-lockout pin that can be installed when using the blade for dirt applications.



FEATURES INCLUDE

- Available in 84", 96", 108", and 120" widths
- 28" blade height
- Optional bolt-on 8" height extension
- Full-trip moldboard
- Steel cutting edge
- Hydraulic angle

PART NUMBER	STRAIGHT WIDTH	ANGLED WIDTH	ANGLE	HEIGHT	WEIGHT
123470	84"	72 1/2"	30°	28"	901 lbs
123475	96"	83"	30°	28"	946 lbs
123480	108"	93"	30°	28"	986 lbs
123485	120"	104"	30°	28"	1,016 lbs

SNOW BLADE STANDARD DUTY SERIES 2 MULTI-PURPOSE

The Blue Diamond® Standard Duty Series 2 Multi-Purpose Blade is great for snow and light dirt work. At 22" tall, this blade is a great fit for most users and has an optional 8" height extension that can be bolted on for high-volume applications. The curved back keeps the material rolling for maximum efficiency. Adjustable skid shoes allow the cutting edge to land perfectly every time. The full-trip moldboard protects the operator and equipment from hidden obstacles or curbs. These blades have a trip-lockout pin that can be installed when using the blade for dirt applications.



SHOWN WITH OPTIONAL HEIGHT EXTENSION

PART NUMBER	STRAIGHT WIDTH	ANGLED WIDTH	ANGLE	HEIGHT	WEIGHT
123415	72"	62 1/4"	30°	22"	560 lbs
123420	84"	72 1/2"	30°	22"	590 lbs

FEATURES INCLUDE

- Available in 72" and 84" widths
- 22" blade height
- Optional bolt-on 8" height extension
- Full-trip moldboard
- Steel cutting edge
- Hydraulic angle

SNOW PLOW V-BLADE

The Blue Diamond® Snow Plow V-Blade is a versatile, heavy duty V-style blade that can be used both for snow and for dirt work. The electric-over-hydraulic controls allow this blade to be used in a conventional-style straight blade. The V-back style pushes off to both sides and the V-forward setting scoops material. The trip function has a lockout for use in dirt, and the electrical hookup can be set for use with any skid steer model.



PART NUMBER	MODEL	ANGLED WIDTH	WEIGHT
120500	6' Without Float	63.87"	823 lbs
120505	6' W/Float	63.87"	823 lbs
120510	7' Without Float	78.38"	863 lbs
120515	7' W/Float	78.38"	863 lbs
120520	8' Without Float	84.87"	903 lbs
120525	8' W/Float	84.87"	903 lbs
120530	9' Without Float	95.38"	943 lbs
120535	9' W/Float	95.38"	943 lbs

FEATURES INCLUDE

- Best for snow and light dirt applications
- V, scoop, and angle up to 30° left or right
- Trip springs for snow; trip lockout for dirt applications
- Replaceable cutting edge; adjustable skid shoes
- Rolled moldboard for better material flow
- Available for mini-machines

SNOW BLOWER EXTREME DUTY

The Blue Diamond® Extreme Duty Snow Blower is engineered for years of use. A high-pressure bypass relief system eliminates the need for shear pins during sudden stops. With a choice of widths and motor packages, you can find the optimal size of snow blower to match your skid steer or compact track loader's capacity.



PART NUMBER	MODEL	BEST FLOW	WEIGHT
119098	68" Snow Blower	11-16 GPM	915 lbs
119099	68" Snow Blower	17-20 GPM	915 lbs
119100	68" Snow Blower	21-23 GPM	915 lbs
119103	72" Snow Blower	17-20 GPM	950 lbs
119104	72" Snow Blower	21-23 GPM	950 lbs
119105	72" Snow Blower	24-25 GPM	950 lbs
119106	72" Snow Blower	26-29 GPM	950 lbs
119107	72" Snow Blower	30-40 GPM	950 lbs
119109	84" Snow Blower	21-23 GPM	1,050 lbs
119110	84" Snow Blower	24-25 GPM	1,050 lbs
119111	84" Snow Blower	26-29 GPM	1,050 lbs
119112	84" Snow Blower	30-40 GPM	1,050 lbs

FEATURES INCLUDE

- 4-blade fan, 22" diameter, 6 1/2" deep
- 16" auger with teeth and 2 1/4" x 1/4" ribbon flighting
- No shear pins; high-pressure bypass relief system
- No chains; direct-drive auger and fan
- 270° hydraulic rotary chute angle with 7" opening
- Hydraulic chute deflector
- Adjustable steel skid shoes
- 7-gauge steel fan housing
- 10-gauge steel blower shell
- 1/4" end plates
- High-strength corner bracing
- Heavy duty polyurethane idler wheels
- Bolt-on grader cutting edge



SNOW PUSHER STANDARD & HEAVY DUTY

The Blue Diamond® Standard and Heavy Duty Snow Pushers offer excellent value for anyone from light users to commercial snow removal contractors. Both models use an adjustable rubber cutting-edge and bolt-on wear shoes made from AR400. The rolled moldboard keeps the snow load live to reduce the host machine horsepower needed to move large snow loads. The Heavy Duty model uses thicker wear shoes, heavier side plates, and more crossbraces than the Standard Duty model. A vertical brace ties the crossbraces together to spread out the impact force on the Heavy Duty unit.



PART NUMBER	MODEL	WEIGHT
120111	60" Snow Pusher, W/Rubber Edge	625 lbs
120113	72" Snow Pusher, W/Rubber Edge	650 lbs
120115	96" Snow Pusher, W/Rubber Edge	835 lbs
120135	72" Snow Pusher, Heavy Duty	624 lbs
120150	96" Snow Pusher, Heavy Duty	770 lbs
120155	120" Snow Pusher, Heavy Duty	839 lbs
120114	72" Snow Pusher, Pull Back Option, Standard/HD	100 lbs
120117	96" Snow Pusher, Pull Back Option, Standard/HD	132 lbs
120122	120" Snow Pusher, Pull Back Option, Standard/HD	165 lbs
220330	Optional Poly Skid Shoe (Req 2)	14 lbs



SOD ROLLER



The Blue Diamond® Sod Roller makes laying large sod rolls simple. Slide the roller shaft through the center of the roll, then pick it up with the attachment and roll sod out. The sod roll can be mounted to roll out while driving either forward or in reverse.

PART NUMBER	MODEL	WEIGHT
102202	36" Sod Roller with 32" Arms	205 lbs
102200	36" Sod Roller with 40" Arms	235 lbs
102206	42" Sod Roller with 32" Arms	251 lbs
102210	42" Sod Roller with 40" Arms	251 lbs
102216	50" Sod Roller with 32" Arms	268 lbs
102215	50" Sod Roller with 40" Arms	284 lbs
302310	36"- 48" Adjustable Sod Roller with 32" Arms	265 lbs
302305	36"- 48" Adjustable Sod Roller with 40" Arms	280 lbs

Part numbers listed are not machine specific. Specify which mount is needed.



FIXED WIDTH MODEL



ADJUSTABLE WIDTH MODEL



STUMP GRINDER EXTREME DUTY

This tough package has it all! It has the highest torque in its class, it is compact, it cuts forward or in reverse, and it has great visibility! Using an extremely durable piston motor and Greenteeth® setup, the Blue Diamond® Extreme Duty Stump Grinder will push through the most demanding applications. A skid steer is limited in its ability to produce hydraulic horsepower, but this stump grinder is designed to maximize performance. Being engineered to cut while moving forward or in reverse sets this machine ahead of its rivals, which are often limited to a single direction. Spend less on fuel! This highly efficient motor can keep your RPMs down in some applications. Spend less time on each stump and increase your profitability. We are sure you will agree that it's worth going with the best!



PART NUMBER	MODEL	MOTOR	BEST FLOW	WEIGHT
104110	24" Wheel, Standard Flow	60 CC	16-20 GPM	747 lbs
104120	24" Wheel, Standard Flow	75 CC	20-25 GPM	745 lbs
104130	24" Wheel, Standard Flow	90 CC	25-29 GPM	740 lbs
104210	26" Wheel, High Flow	130 CC	29-33 GPM	801 lbs
104220	26" Wheel, High Flow	150 CC	33-39 GPM	784 lbs
104230	26" Wheel, High Flow	170 CC	39-45 GPM	787 lbs

FEATURES INCLUDE

- High-torque radial piston motor
- Cuts when moving forward or in reverse
- Excellent visibility
- Compact
- No electrical power needed
- Requires case drain line
- 3 standard-flow models and 3 high-flow models

SWING ARM

The Blue Diamond® Swing Arm Stump Grinder is an incredibly efficient tool for commercial stump grinding. The unique design of this model makes it equal in performance to a 75 HP dedicated stump grinder. This model allows the host machine to remain stationary and can be operated using the OEM controls or a universal control box.



PART NUMBER	MODEL	MOTOR	BEST FLOW	WEIGHT
104605	Swing Arm, High Flow	130 CC	29-33 GPM	1,472 lbs
104610	Swing Arm, High Flow	150 CC	33-39 GPM	1,459 lbs
104615	Swing Arm, High Flow	170 CC	39-45 GPM	1,740 lbs

FEATURES INCLUDE

- 6-way cutting positioning (up/down, side/side, in/out)
- Piston motor for best-in-class cutting efficiency
- Built with oversized components for longevity
- 26" wheel with 30 durable green teeth
- Push blade for backfill
- Best suited for machines with 50-95 HP
- Chain guard for debris

TRAILER SPOTTER



The Blue Diamond® Trailer Spotter is a great tool for moving trailers in tight areas with your skid steer.

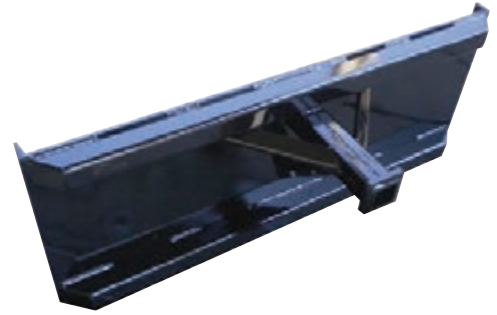

PART NUMBER	MODEL	WEIGHT
112010	Trailer Spotter, Skid Steer Mount	118 lbs

TREE BOOM

The Blue Diamond® Tree Boom is designed for setting new trees or moving cut trees. The 3,500, 5,000 or 6,000 lb capacity makes this attachment useful in many applications. This attachment also features a hole for mounting a chain, strap, or our optional clevis with swivel hook.



STANDARD DUTY



HEAVY DUTY SERIES 2



SEVERE DUTY
SHOWN WITH OPTIONAL SWIVEL
HOOK AND CLEVIS

PART NUMBER	MODEL	WEIGHT
112005	Tree Boom, 3,500 Lift Cap	169 lbs
112003	Tree Boom, Heavy Duty Series 2, 5,000 Lift Cap	328 lbs
112002	Tree Boom, Severe Duty, 6,000 Lift Cap	400 lbs
212050	Optional Clevis W/Swivel Hook	4 lbs

Applications:

- Nurseries
- Landscaping
- Setting pipe in trenches
- Mechanical contracting
- Scrap yards
- Lifting feed totes

TREE GRUBBER EXTREME DUTY

The Blue Diamond® Tree Grubber attachment is an effective skid steer tool for permanent removal of unwanted shrubs and trees. Designed to prevent regrowth from the taproot, the grubber can protect your land from persistent invasive brush and trees.



PART NUMBER	MODEL	WEIGHT
102100	Tree Grubber, Extreme Duty	285 lbs
102105	Tree Grubber, Extreme Duty, W/Teeth	345 lbs



TREE PULLER STANDARD & HEAVY DUTY

The Blue Diamond® Tree Puller is an excellent tool for removing small trees and shrubs when the roots need to be pulled out. The serrated teeth lock onto the base of the tree, then pry or pull roots and all from the ground, shake the dirt out of the roots, and carry removed tree or shrub to where you want to stack your material. The heavy duty version has 2 rows of teeth for added grip.

FEATURES INCLUDE

- Heavy Duty Tree Puller has protected cylinder
- Heavily gusseted quick attach
- Opens to 11"
- 1-year warranty

PART NUMBER	MODEL	WEIGHT
127006	Tree & Post Puller, Standard Duty	291 lbs
127010	Tree & Post Puller, Heavy Duty	415 lbs



STANDARD DUTY



HEAVY DUTY

TREE SHEAR

The Blue Diamond® Tree Shear cuts trees up to 12" diameter with ease. The powerful 5" x 12" cylinder produces 29 tons of force at 2,500 psi. By simply pulling a pin, the shear will rotate 90° for cutting limbs or felled trees.

PART NUMBER	MODEL	WEIGHT
128005	Tree Shear, Cuts To 12"	1,123 lbs



CUTTER ROTATES 90°

T1 STEEL



TRENCHER

The Blue Diamond® Trencher is extremely durable and has a number of features to make it more productive than our competitors' models. The extended auger carries the dirt farther from the trench to prevent it from falling back in. The self-adjusting crumber brings any residual dirt back to the chain to be removed from the trench for a very clean finish. A selection of chain options is available from dirt to rock and with varying widths. An adjustable foot keeps the trench depth consistent. The Eaton drive motor mounts to an industry-leading planetary drive that provides the high torque to the digging chain. This attachment has been designed and built for the serious contractor who depends on production and reliability. And it is made in USA with American components!

PART NUMBER	MODEL	WEIGHT
131110	Trencher, 36"Depth, 4" Dirt Chain	390 lbs
131115	Trencher, 36"Depth, 6" Dirt Chain	575 lbs
131120	Trencher, 36"Depth, 8" Dirt Chain	585 lbs
Combo Chains		
113125	Trencher, 36"Depth, 4" Combo Chain	697 lbs
131130	Trencher, 36"Depth, 6" Combo Chain	780 lbs
131135	Trencher, 36"Depth, 8" Combo Chain	780 lbs
Rock Chains		
131140	Trencher, 36"Depth, 4" Rock Chain	751 lbs
131145	Trencher, 36"Depth, 6" Rock Chain	751 lbs
131150	Trencher, 36"Depth, 8" Rock Chain	751 lbs
Earth Chains		
131210	Trencher, 48"Depth, 6" Earth Chain	1,120 lbs
131215	Trencher, 48"Depth, 8" Earth Chain	1,120 lbs
131220	Trencher, 48"Depth, 10" Earth Chain	1,120 lbs
131225	Trencher, 48"Depth, 12" Earth Chain	1,120 lbs
Combo Chains		
131230	Trencher, 48"Depth, 6" Combo Chain	1,075 lbs
131235	Trencher, 48"Depth, 8" Combo Chain	1,120 lbs
131240	Trencher, 48"Depth, 10" Combo Chain	1,120 lbs
131245	Trencher, 48"Depth, 12" Combo Chain	1,120 lbs
Rock Chains		
131250	Trencher, 48"Depth, 6" Rock Chain	1,075 lbs
131255	Trencher, 48"Depth, 8" Rock Chain	1,120 lbs
131260	Trencher, 48"Depth, 10" Rock Chain	1,120 lbs
131265	Trencher, 48"Depth, 12" Rock Chain	1,120 lbs
Mounts		
131005	Trencher Mount Skid Steer	146 lbs
131006	Trencher Mount, Wide Frame Side Shift	200 lbs



FEATURES INCLUDE

- Extended auger
- Self-adjusting crumber
- Adjustable foot to keep the trench depth consistent
- Eaton drive motor
- Side shift option



High-flow models listed on next page

TRENCHER HIGH-FLOW (28-45 GPM)

PART NUMBER	MODEL	WEIGHT
131300-HF	Trencher, High Flow, 60" Depth, 6" Combo	1,020 lbs
131305-HF	Trencher, High Flow, 60" Depth, 8" Combo	1,040 lbs
131310-HF	Trencher, High Flow, 60" Depth, 12" Combo	1,080 lbs

Includes Crumber



VIBRATORY ROLLER



The Blue Diamond® Vibratory Rollers are available in 73" and 84" working widths. All models feature hydraulically powered exciter systems designed with oil-mist lubrication. All models minimize exciter shaft deflection, lower operating temperatures, and provide our customers with the industry's lowest incidence of bearing and seal failure. A knockdown blade is integral to the roller frame. Vibrating drums are isolated from the frame, minimizing transmission of vibration to the host machine. All models come with a universal quick-attach system. Smooth or pad foot drum options are available.

FEATURES INCLUDE

- Industry leading bearing design
- Integral knockdown blade
- Smooth or pad foot models
- Exciter systems are oil mist lubricate
- Vibrating drums are effectively isolated from the roller frame
- 12 heavy duty rubber shock mounts
- Control valve block compensates for the correct flow of oil to prevent over speeding and over pressure of the exciter shaft
- Universal adapter plate
- Drive motor is inside a heavy duty steel frame

PART NUMBER	MODEL	WEIGHT
124010	73" Vibratory Roller, Smooth	2,050 lbs
124015	73" Vibratory Roller, Pad Foot	2,210 lbs
124030	84" Vibratory Roller, Smooth	2,300 lbs
124035	84" Vibratory Roller, Pad Foot	2,450 lbs



PAD FOOT



SMOOTH



AUGER DRIVE EXTREME DUTY - SERIES 2

Blue Diamond® Extreme Duty Series 2 Auger Drive offers the ultimate in performance, quality, and cost effectiveness. Designed with high-grade materials and innovation, this design allows the gearbox to go down the hole, maximizing drilling depth while eliminating downtime. These drives are perfect for drilling and augering in most ground conditions.



FEATURES INCLUDE

- Compact high torque manufactured gearbox
- 2-piece shaft design ensures maximum side load ratings
- 2" hex shaft comes standard but also available with 2 9/16" round
- Lifetime shaft pull-out warranty, 5-year planetary drive warranty, 3-year hydraulic motor warranty, and 1-year mount and mount components warranty

MODEL	EX1	EX2	EX3	EX4	EX4HF	EX5HF	EX6HF	EX7HF
PART NUMBER	305705	305708	305712	305715	305720	305725	305728	305730
TORQUE FT-LBS @ 3,000 PSI	1,467	2,254	2,829	3,275	3,583	3,903	4,909	6,162
MAX TORQUE FT-LBS @ 3,500 PSI	1,712	2,630	3,300	3,821	4,180	4,553	5,728	7,189
RECOMMENDED FLOW (GPM)	6-16	10-26	10-30	10-30	10-36	10-36	12-36	14-36
PEAK EFFICIENCY (GPM)	8-11	12-16	17-20	19-23	21-26	—	—	—
MOTOR TYPE	Eaton							
MAX PRESSURE – DO NOT EXCEED	3,500 psi @ 16 GPM				3,500 psi @ 27 GPM			
MAX FLOW – DO NOT EXCEED	30 GPM @ 1,800 psi				42 GPM @ 2,250 psi			
MAX HP	33				55			
PRESSURE RELIEF VALVE	N/A				Included			
STANDARD OUTPUT SHAFT	2" Hex					2 1/2" Hex		
MAX DRILLING DIAMETER CLAY/SHALE	12"	24"				30"		
MAX DRILLING DIAMETER EARTH	24"	30"		40"			48"	
WEIGHT (LBS)	101	123	125	180	290 lbs	477 lbs	438 lbs	
OVERALL LENGTH (IN)	24.5"	25.9"		29"		33.7"		
DIAMETER (IN)	7.4"	9.4"				11.4"		

Available to fit machines up to 60,000 lbs.

HYDRAULIC BREAKER HAMMER



Our 10-year quest to develop a superior hydraulic breaker is now available from Blue Diamond®. This “hammer” design offers technology, simplicity, reliability, ease of setup, and service support. No more downtime! Get started on your demolition, construction, and quarry jobs now. A 3-year warranty comes with all breakers.



EXCAVATOR
ATTACHMENTS

FEATURES INCLUDE

- 3-year warranty
- Mono-block design / no tie rods
- Anti-blank firing system hydraulic brake
- No re-gassing needed
- Only 2 internal moving parts
- 2 speed control / variable stroke
- Quiet Operation
- Self-regulating
- Body bushings around piston

PART NUMBER	MODEL	WORKING PRESSURE	MAX OIL FLOW	FREQUENCY (BPM)	OPERATING WEIGHT	TOOL DIAMETER	ENERGY CLASS	CARRIER WEIGHT	(PSI) BACK PRESSURE
135005	HB50	1,750	7	1,200	132 LBS	1.5	100	1,500-2,650 lbs	290-360
135009	HB95		11		220 LBS	1.8	200	2,650-4,000 lbs	
135016	HB165		13		370 LBS	2.2	400	4,000-6,600 lbs	
135021	HB210		16	1,100	463 LBS	2.5	500	6,100-9,900 lbs	
135030	HB300		21.2		661 LBS	2.9	700	8,800-15,500 lbs	
135040	HB400		29.2	900	882 LBS	3.1	1,000	13,500-20,900 lbs	
135053	HB530	32	1,169 LBS		3.3	1,200	17,650-25,350 lbs		
135095	HB950	34	2,161 LBS		4	2,000	22,000-33,000 lbs		
135098	HB1400	2,050	37	600-800	2,976 LBS	4.6	3,000	30,000-50,000 lbs	145
135100	HB1800		53	490-630	3,968 LBS	5.4	4,000	48,000-70,000 lbs	
135105	HB2500		61	460-630	5,291 LBS	6	5,000	60,000-80,000 lbs	
135110	HB3000		75	380-500	6,614 LBS	6.5	7,000	70,000-110,000 lbs	



BREAKER CUTAWAY

ACCUMULATOR:

The large dimension accumulator with diaphragm supplies power to the breaker and protects the excavator hydraulic pump and pipeline from damage due to the backshock blows

ISOLATION:

An isolation with vulcanized polyurethane between the metal case and the monoblock drastically reduced noise and vibrations

MONOBLOCK:

The absence of a tie rod increases reliability and makes eventual servicing more simple and economical

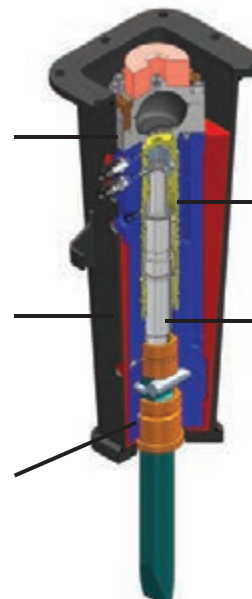

BODY BUSHINGS:

In case of a damaged piston, body bushings protect the monoblock

HYDRAULIC BRAKE:

A hydraulic brake on the piston prohibits the breaker from harmful blank firing

BRUSH CUTTER HEAVY DUTY MINI EXCAVATOR

The Blue Diamond® Heavy Duty Brush Cutter has an extremely rugged direct-drive system with a large flywheel that stores energy and keeps the blades cutting, even in difficult conditions. All models use a 3-blade system with straight blades to give better cutting capabilities than the competitive units.

FEATURES INCLUDE

- Bidirectional operation
- Closed deck
- 3 double-sided blades
- Greasable drive system
- 1/4" deck thickness
- 4" diameter cutting capacity
- 3 1/2" forged drive spindle
- 5-year warranty on drive spindle
- 1-year warranty

PART NUMBER	MODEL	BEST FLOW	WEIGHT
103600	36" Heavy Duty W/ 80CC	13-24 GPM	552 lbs*
103610	36" Heavy Duty W/ 100CC	29-36 GPM	675 lbs*
103650	42" Heavy Duty W/ 80CC	13-24 GPM	662 lbs*
103660	42" Heavy Duty W/ 100CC	25-31 GPM	662 lbs*
103709	50" Heavy Duty W/ 80CC	13-22 GPM	956 lbs*
103712	50" Heavy Duty W/ 100CC	23-28 GPM	956 lbs*
103713	50" Heavy Duty W/ 125CC	28-33 GPM	826 lbs*
103714	50" Heavy Duty W/ 160CC	34-41 GPM	1,216 lbs*

Rubber flaps available for 36" and 42" models.

*Attachment only. Mount weight is additional and varies by machine



42"



50"



SEVERE DUTY MINI EXCAVATOR

The Blue Diamond® Severe Duty Brush Cutter provides the largest cutting capacity in its class. The high-torque piston motor maintains incredible torque through its RPM range. Industry-leading technology introduced on this brush cutter allows the motor to be used without a case drain line, saving added expense and installation time.

FEATURES INCLUDE

- 6" diameter cutting capacity
- Open deck
- Fits 10,000 - 19,000 lb machines
- No case drain needed

PART NUMBER	MODEL	BEST FLOW	WEIGHT
103820	42" SD, 80CC Piston Motor	16-26 GPM	729 lbs*

*Attachment only. Mount weight is additional and varies by machine



BRUSH CUTTER SEVERE DUTY SERIES 2 MINI EXCAVATOR

The Blue Diamond® Severe Duty Brush Cutter provides the largest cutting capacity in its class. The high-torque piston motor maintains incredible torque through its RPM range. Industry-leading technology introduced on this brush cutter allows the motor to be used without a case drain line, saving added expense and installation time.

FEATURES INCLUDE

- 6" diameter cutting capacity
- Deck cutouts to expose blades
- Fits 10,000 - 19,000 lb machines
- No case drain needed
- 3/4" thick blade carrier
- Direct drive is filled with oil
- Improved wire protection for the oil seal

PART NUMBER	MODEL	BEST FLOW	WEIGHT
103820-2	42" SD, 80CC Piston Motor	16-26 GPM	718 lbs*

**Attachment only. Mount weight is additional and varies by machine*



BRUSH CUTTER EXTREME DUTY

This powerful brush cutter is a serious attachment for clearing land! The piston motor will tear through large brush with ease, boasting 40% more torque than geroler/gerotor type motors. The cut-away design allows better access to larger material and keeps grass standing while cutting, leaving a cleaner finish. The three AR400 blades make quick work of brush or grass. Available only in 60" cutting width.

FEATURES INCLUDE

- 6" cutting capacity
- Cut away side
- Case drain required on host machine
- Grease-filled drive dramatically improves bearing life
- Fits 28,000-38,000 lb machines
- Bearing seal protection kit under deck
- 1-year warranty

PART NUMBER	MODEL	BEST FLOW	WEIGHT
103850	60" Excavator, Extreme Duty, 150CC Piston Motor	22-30 GPM	1,790 lbs*

**Attachment only. Mount weight is additional and varies by machine*



BRUSH CUTTER SEVERE DUTY

The Blue Diamond® Severe Duty 60” Excavator Cutter is the big brother to the 60” Extreme Duty Excavator Cutter. Rated to fit up to 60,000 lb excavators, this cutter will clear any piece of land that you need it to. It is great for reaching down embankments and in hard to access areas. The 1/2” thick deck with strong reinforcements is sure to hold up to whatever you demand of it.



FEATURES INCLUDE

- 7” cutting capacity
- Cut away side
- Case drain required on host machine
- Grease-filled drive dramatically improves bearing life
- Fits 38,000-60,000 lb machines
- Bearing seal protection kit under deck
- 1-year warranty

PART NUMBER	MODEL	BEST FLOW	WEIGHT
303860	60” Excavator , SD, 150CC Piston Motor	22-30 GPM	2,447 lbs*
303865	60” Excavator , SD, 200CC Piston Motor	30-40 GPM	2,397 lbs*
303867	60” Excavator , SD, 250CC Piston Motor	40-50 GPM	2,403 lbs*

**Attachment only. Mount weight is additional and varies by machine*



EXCAVATOR BUCKET

HEAVY DUTY

Blue Diamond® Buckets are our most popular general purpose and heavy duty for excavators. They are used for digging in a broad range of materials, including dirt, clay, and rock. Optional side cutters are available for all buckets for machines 12,000 lbs and larger. We use AR400 on the sides, cutting edge, mounting brackets, and reinforcing wear bars. AR400 is much stronger than T1 and more wear-resistant. The shell is constructed from A-572-50 because it has to be rolled. J Series Style Teeth are standard, but other teeth are available.



EXCAVATOR BUCKETS FOR JOHN DEERE			EXCAVATOR BUCKETS FOR TAKEUCHI			EXCAVATOR BUCKETS FOR CAT			EXCAVATOR BUCKETS FOR KUBOTA		
PART NUMBER	MODEL	SIZE	PART NUMBER	MODEL	SIZE	PART NUMBER	MODEL	SIZE	PART NUMBER	MODEL	SIZE
7010512	27/35 ZTS Coupler	12"	7051012	TB135/ TB235	12"	7100512	303/303.5 304E	12"	7200512	KX057 Quick Coupler	12"
7010518		18"	7051018		18"	7100518		18"	7200518		18"
7010524		24"	7051024		24"	7100524		24"	7200524		24"
7010530		30"	7051030		30"	7100530		30"	7200530		30"
7011012	50/60 ZTS Coupler	12"	7051512	TB145/ TB250	12"	7101012	304C 304C-CR	12"	7200536	KX121 KX040 KX91 Quick Coupler	36"
7011018		18"	7051518		18"	7101018		18"	7201512		12"
7011024		24"	7051524		24"	7101024		24"	7201518		18"
7011030		30"	7051530		30"	7101030		30"	7201524		24"
7011036		36"	7051536		36"	7101036		36"	7201530		30"
7011512	75/85 Mount	12"	7052012	TB260	12"	7102112	307E 308D & E	12"	7201536	KX161 Quick Coupler	36"
7011518		18"	7052018		18"	7102118		18"	7203012		12"
7011524		24"	7052024		24"	7102124		24"	7203018		18"
7011530		30"	7052030		30"	7102130		30"	7203024		24"
7011536		36"	7052036		36"	7102136		36"	7203030		30"
7012018	120/135 Mount	18"	7052518	TB1140	18"	7103018	311/312 313/314	18"	7203036		36"
7012024		24"	7052524		24"	7103024		24"			
7012036		36"	7052530		36"	7103036		36"			
7012042		42"	7052536		42"	7103042		42"			

BUCKETS SCREENING

The Blue Diamond® Screening Bucket is used for the screening, aerating, separating and mixing of soils, aggregates, wood chips and compost. The efficient screening process is created by the star rotors agitating the material, causing the fines to flow through the rotating stars leaving the oversized material in the bucket. A hydraulic flow regulator is included to maintain correct RPM for poly stars.



PART NUMBER	MODEL	HOST MACHINE SIZE	WEIGHT
145110	33" MODEL 3-33E	Fits 6K-11K	557 lbs
145115	40" MODEL 4-40HE	Fits 11K-22K	1,104 lbs
145117	47" MODEL 4-47HE	Fits 22K-30K	1,179 lbs
145120	60" MODEL 4-60HE	Fits 28K-35K	1,585 lbs
145135	60" MODEL 6-60HDX	Fits 35K-44K	1,635 lbs

Optional comb kits.

FEATURES INCLUDE

- 1" or smaller material will flow through
- Horizontal shafts, fitted with poly stars that rotate in the same upwards direction
- Hardened steel cutting edge
- 2-position mount plate
- Hoses and couplers included
- Mounts available to fit most machines
- 1-year warranty

LOG SPLITTER

The Blue Diamond® Heavy Duty Excavator Log Splitter is a great tool to get your firewood ready. Fit up to 22" logs and split them with the powerful 25-ton cylinder. The bolt-on mounting plate allows the operator to switch mounts when changing machines. It can be mounted parallel or perpendicular to the operator for visibility preference. The reinforced tubular frame is designed to withstand many years of use.



FEATURES INCLUDE

- Fits up to 22" long
- 25-ton cylinder
- Protected hose routing
- Bolt-on mount for use with multiple machines
- Single or 4-way wedge
- Perpendicular or parallel to operator for preferred visibility
- Rated for 8,000-20,000 lb. excavators



PART NUMBER	MODEL	DIMENSIONS	WEIGHT (WITHOUT MOUNT OR WEDGE)
150112	HD Excavator Log Splitter	77" L x 19" W x 13" H	340 lbs

PLATE COMPACTOR

The Blue Diamond® Plate Compactor can be used on excavators, backhoes, skid steers, and mini machines. The industry leading technology protects the machine from excessive vibrations, yet offers excellent compaction ability.

FEATURES INCLUDE

- Advanced technology for low vibration and noise
- Same width as standard trenching buckets
- High-pressure cut off valve to protect motor

PART NUMBER	MODEL	HOST MACHINE SIZE	WEIGHT
151005	C310, 24"X12"	Fits 5K-12K	552 lbs
151010	C410, 32"X16"	Fits 12K-22K	880 lbs
151015	C610, 48"X24"	Fits 24K-42K	2,000 lbs



EXCAVATOR
ATTACHMENTS

RAKE

FITS 6K-10K LB. MACHINES

The Blue Diamond® Rake is an excellent tool for cleaning roots, limbs, and other debris while leaving behind valuable soil. Quickly turn your excavator into the ultimate cleanup machine! Available to fit 6,000 lbs machines or larger.

PART NUMBER	MODEL	HEIGHT	WEIGHT
170405	24" Wide Excavator Rake	21"	185 lbs
170410	30" Wide Excavator Rake	21"	205 lbs
170415	36" Wide Excavator Rake	21"	225 lbs
170420	42" Wide Excavator Rake	21"	245 lbs
170425	48" Wide Excavator Rake	21"	265 lbs
170430	54" Wide Excavator Rake	21"	285 lbs
170435	60" Wide Excavator Rake	21"	305 lbs



FITS 10K-15K LB. MACHINES

PART NUMBER	MODEL	HEIGHT	WEIGHT
170470	42" Wide Excavator Rake	28"	340 lbs
170475	48" Wide Excavator Rake	28"	372 lbs
170480	54" Wide Excavator Rake	28"	404 lbs
170485	60" Wide Excavator Rake	28"	436 lbs
170490	66" Wide Excavator Rake	28"	468 lbs

ROCK & CONCRETE GRINDER

The Blue Diamond® Rock & Concrete Grinders are a must-have tool for any application where rock, concrete, or asphalt need to be removed. They allow for a clean trench to be made with vertical walls. Six different models are available with mounts to fit most excavators and skid steers.



APPLICATIONS:

- Trenching
- Demolition
- Rock Excavation

FEATURES INCLUDE

- All American-made parts & components
- Powerful high torque hydraulic motors
- Robust cutting drums to ensure maximum production & prolonged life
- Customizable drums to accommodate performance maximized applications
- Durable spur gears & housing
- Bolt on mount for excavator or skid steer

PART NUMBER	MODEL	WEIGHT (WITHOUT MOUNT)	CUTTING WIDTH	HEAD DIAMETER	REQUIRED FLOW (GPM)	CARRIER WEIGHT
159010	G1S	265 lbs	19"	9"	5-12	1,300-5,000 lbs
159015	G1	635 lbs	21"	11"	8-20	6,900-17,000 lbs
159020	G2	1,035 lbs	25"	16 1/2"	12-26	17,000-30,000 lbs
159025	G3	2,045 lbs	31"	22"	30-45	22,000-39,000 lbs
159030	G3XL	2,290 lbs	32"	23"	34-65	33,000-66,000 lbs
159035	G4	4,100 lbs	40"	29"	50-85	50,000-90,000 lbs



TREE GRUBBER

The Blue Diamond® Tree Grubber attachment is an effective excavator tool for permanent removal of unwanted shrubs and trees. Designed to prevent regrowth from the taproot, the grubber can protect your land from persistent invasive brush and trees.

FEATURES INCLUDE

- Heavy Duty 1" steel construction
- Bolt-on mount for easy machine exchange
- Dull V to grab root instead of cutting through
- Serrated edge for extra grip
- The 18 x 19 version fits 6,000-20,000 lb machines
- The 24 x 24 version fits 20,000-40,000 lb machines

PART NUMBER	MODEL	WEIGHT
102110	Tree Grubber, W/18 x 19 Blank Plate	285 lbs
102150	Tree Grubber, W/24 x 24 Blank Plate	342 lbs



VIBRATORY POST DRIVER SERIES 2

The Blue Diamond® Vibratory Series 2 Post Driver is the best post driver for full-size skid steers, mini skid steers, and excavators, ideal for both commercial and for rental fleet use! Useful for many industries, a vibratory post driver makes the job faster and more efficient for works in construction, agriculture, solar installation, and more!

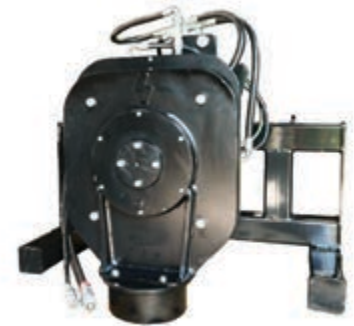

PART NUMBER	MODEL	WEIGHT
100502	Vibrating Post Driver Case Drain Req On Machine (Add Mount)	264 lbs
100507	Vibrating Post Driver W/Tilt Case Drain Req On Machine (Add Mount)	400 lbs

FEATURES INCLUDE

- Optional tilt function allows for 10 degrees of adjustment
- Hydraulic orbital technology maximizes auxiliary flow
- Available with 4" - 12" round and flat post adapters
- Compact design that is easy to transport and store
- Requires 7-26 GPM auxiliary flow and case drain
- OEM and universal wiring harnesses available
- Easily swap between machines with the interchangeable mount





3-POINT CONVERSION ADAPTER

The Blue Diamond® 3-Point Conversion Adapter allows you to use your rear 3-point farm tractor attachments on the front of your skid steer or tractor. Great for moving or using farm implements that do not require PTO.



PART NUMBER	MODEL	WEIGHT
113105	Universal To 3 Pt Hitch Conversion, Cat 1	147 lbs
113110	Universal To 3 Pt Hitch Conversion, Cat 2	225 lbs



AUGER DRIVE EXTREME DUTY - SERIES 2

Blue Diamond® Extreme Duty Series 2 Auger Drive offers the ultimate in performance, quality, and cost effectiveness. Designed with high-grade materials and innovation, this design allows the gearbox to go down the hole, maximizing drilling depth while eliminating downtime. These drives are perfect for drilling and augering in most ground conditions.



PART NUMBER	MODEL	BEST FLOW	WEIGHT
305705	EX1, W/2" HEX SHAFT	8-11 GPM	260 lbs
305708	EX2, W/2" HEX SHAFT	12-16 GPM	277 lbs
305712	EX3, W/2" HEX SHAFT	17-20 GPM	282 lbs
305715	EX4, W/2" HEX SHAFT	19-23 GPM	342 lbs
305720	EX4HF, W/2" HEX SHAFT	21-26 GPM	337 lbs

Mounts available to fit most tractors.

FEATURES INCLUDE

- Compact high torque manufactured gearbox
- 2-piece shaft design ensures maximum side load ratings
- 2" hex shaft comes standard but also available with 2 9/16" round
- Lifetime shaft pull-out warranty, 5-year planetary drive warranty, 3-year hydraulic motor warranty, and 1-year mount and mount components warranty

MODEL	EX1	EX2	EX3	EX4	EX4HF
PART NUMBER	305705	305708	305712	305715	305720
TORQUE FT-LBS @ 3,000 PSI	1,467	2,254	2,829	3,275	3,583
MAX TORQUE FT-LBS @ 3,500 PSI	1,712	2,630	3,300	3,821	4,180
RECOMMENDED FLOW (GPM)	6-16	10-26	10-30	10-30	10-36
PEAK EFFICIENCY (GPM)	8-11	12-16	17-20	19-23	21-26
MOTOR TYPE	Eaton				
MAX PRESSURE – DO NOT EXCEED	3,500 psi @ 16 GPM			3,500 psi @ 27 GPM	
MAX FLOW – DO NOT EXCEED	30 GPM @ 1,800 psi			42 GPM @ 2,250 psi	
MAX HP	33			55	
PRESSURE RELIEF VALVE	N/A			Included	
STANDARD OUTPUT SHAFT	2" Hex				
MAX DRILLING DIAMETER CLAY/SHALE	12"	24"			
MAX DRILLING DIAMETER EARTH	24"	30"		40"	
WEIGHT (LBS)	101	123	125	180	
OVERALL LENGTH (IN)	24.5"	25.9"		29"	
DIAMETER (IN)	7.4"	9.4"			

BALE SQUEEZE

The Blue Diamond® Bale Squeeze is an excellent alternative to a bale spear, especially when using wrapped bales. This versatile attachment can pick up bales whether they are sitting flat or on their side.



PART NUMBER	MODEL	WEIGHT
111105	Bale Squeeze 2,000 Capacity	400 lbs
211110	Optional Bolt-On Grippers (Requires 2)	60 lbs

FEATURES INCLUDE

- Strong tubular design
- 1-year warranty
- Flat-face couplers
- Use on skid steers or tractors with universal or Euro Ag mount
- Opens to 72" for handling up to 60" bales
- Equalizer bar standard

BOX BLADE SCRAPER

The Blue Diamond® Standard Duty Box Blade Scraper is designed for working topsoil, gravel, mulch, or manure. Ideal for use on the farm, at building sites, or for outdoor arenas. This scraper works with 15 hp to 45 hp tractors and is available in 5 widths, from 48" to 96".



For tough jobs, the Heavy Duty Box Blade Scraper will stand up to the tasks required to maintain your farm, building site, or landscaping projects. This unit makes quick work of ripping up dirt, grading and leveling land, or spreading soil. Models are available in 3 working widths from 72" to 96", with adjustable heavy duty ripper shanks, and are compatible with a Category 1 and Category 2 quick hitches, and are designed to work with 30 hp to 70 hp tractors. It comes with a 2-year warranty.



	Standard Duty		Heavy Duty		
PART NUMBERS	426010	426015	426110	426115	426120
MODEL	48"	60"	72"	84"	96"
HORSEPOWER	15-45	15-45	30-70	30-70	30-70
WIDTH	48"	60"	72"	84"	96"
MOLDBOARD HEIGHT	17"				
OVERALL DEPTH	22"				
WEIGHT	290 lbs	323 lbs	530 lbs	586 lbs	640 lbs
NUMBER OF SHANKS	3	4	5	6	6
A-FRAME MATERIAL	3/8"		1/2"		
CUTTING EDGES	6"				
QUICK-HITCH COMPATIBLE	Yes				
HITCH	Category 1		Category 1 and Category 2		

GRADER BLADE

HEAVY DUTY

The Blue Diamond® Grader Blade is our toughest grader blade. These heavy duty models will easily meet all of your land grading, leveling, or backfilling needs. Designed for 45 hp to 75 hp tractors, they feature a 5-position angle adjustment and 3-position tilt adjustment, and use a ratchet jack for the offset adjustment.



FEATURES INCLUDE

- Fits Category 1 and Category 2 hitches
- Ratchet jack offset adjustment
- Used for grading, leveling, and backfilling needs
- 5-position angle moving forward and in reverse
- 3-position tilt adjustment
- 2-year warranty



PULL DIRT



PUSH DIRT

PART NUMBERS	423010	423015	423020
MODEL	6'	7'	8'
HORSEPOWER	45-75	50-75	55-75
WIDTH	72"	84"	96"
MOLDBOARD HEIGHT	17"		
WEIGHT	439 lbs	469 lbs	503 lbs
ANGLE ADJUSTMENT	5-Position, Forward and Reverse		
TILT ADJUSTMENT	3-Position		
OFFSET ADJUSTMENT	Ratchet Jack		
A-FRAME MATERIAL	3/8"		
CUTTING EDGES	6"		
QUICK-HITCH COMPATIBLE	Yes		
HITCH	Category 1 and 2		

DUAL-EDGE GRADER

The Blue Diamond® Dual-Edge Grader can be used to maintain gravel driveways, level a garden plot, and smooth dirt areas including horse arenas and barn floors. It is designed with an adjustable cutting depth, making the shanks optional. These dual-edge graders feature replaceable skid shoes, reversible blades, adjustable blade height, and optional adjustable shanks.



FEATURES INCLUDE

- Dual cutting edges
- Side plates to float the cutting edges along the surface
- Adjustable/removable shanks with replaceable teeth
- Shank adjustment at grade level. 1 1/2" & 3" below grade level
- 2-year warranty

PART NUMBERS	423105	423110	423112	423115	423117	423120	423122	423127
MODEL	48"	60"	60"	72"	72"	84"	84"	96"
HORSEPOWER	20-35	25-55	25-55	35-55	30-70	40-80	30-70	30-70
WEIGHT	421 lbs	447 lbs	490 lbs	545 lbs	530 lbs	700 lbs	586 lbs	640 lbs
HITCH	CAT 1				CAT 1 & 2			

ANGLE BROOM HEAVY DUTY - SERIES 2

The Blue Diamond® Heavy Duty Series 2 Angle Broom is available in manual and hydraulic angles. A simple-to-use control comes with the hydraulic angle model to handle from inside your cab. The 26" bristles are available in poly, or steel, or poly/steel mix and are protected by retractable legs when not in use.



OPTIONAL WATER KIT

FEATURES INCLUDE

- Manual or hydraulic angle
- Stands protect bristles when not in use
- 14-pin OEM connector available
- 1-year warranty
- Optional water kit
- 30° pivot angle

PART NUMBERS	116207	116212	116217	116222	116205	116210	116215	116220
MODEL	60"	72"	84"	96"	60"	72"	84"	96"
ANGLE	Manual				Hydraulic			
WEIGHT	995 lbs	1,300 lbs	1,450 lbs	980 lbs	1,300 lbs	1,450 lbs	850 lbs	1,015 lbs

BROOMS - PUSH HEAVY & STANDARD DUTY

This incredible broom will amaze you! Clean up job sites, push light snow, sweep leaves, squeegee water, or groom ball fields. Add our heavy duty magnet for picking up screws, nails, and other steel debris. The Standard Duty comes with 8 rows of bristles, and the Heavy Duty has 11 rows of bristles. Models are available in 60", 72", or 96" widths.



PART NUMBER	MODEL	WEIGHT	BRISTLES
316030	60" Standard Duty	146 lbs	8 rows
316035	72" Standard Duty	173 lbs	8 rows
316040	60" Push Heavy Duty	206 lbs	11 rows
316045	72" Push Heavy Duty	239 lbs	11 rows
316055	96" Push Heavy Duty	535 lbs	11 rows
116020	Forklift Mount (HD Model Req 116027)	52 lbs	—
116026	Skid Steer Mount (HD Model Req 116027)	187 lbs	—

DISPENSING BUCKET



The Blue Diamond® Dispensing Bucket is great for any flowable material from feed to concrete. The hopper has splash guards around the top to contain material while traveling on rough terrain. The heavy duty chute is enclosed at the back to control the flow and can be removed for transportation or storage.

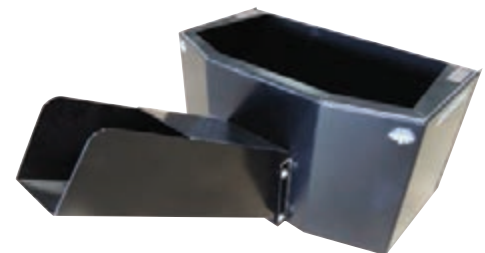

FEATURES INCLUDE

- Available with 1/2-yard or 3/4-yard hopper with tapered front
- Removable chute for cleaning and storage
- Splash guard around top lip
- Available with or without hydraulic door
- 1-year warranty

PART NUMBER	MODEL	WEIGHT
110005	1/2 Yard Dispensing Bucket	393 lbs
110010	1/2 Yard Dispensing Bucket W/Hydraulic Door	403 lbs
110035	3/4 Yard Dispensing Bucket	452 lbs
110040	3/4 Yard Dispensing Bucket W/Hydraulic Door	477 lbs

ROCK BUCKET

PART NUMBER	MODEL	TINE THICKNESS	WEIGHT
108320	66" Standard Duty Rock Bucket	3/8"	424 lbs
108335	72" Standard Duty Rock Bucket	3/8"	465 lbs
108350	78" Standard Duty Rock Bucket	3/8"	512 lbs
108405	66" Extreme Duty Rock Bucket	1/2"	615 lbs
108410	72" Extreme Duty Rock Bucket	1/2"	615 lbs
108415	78" Extreme Duty Rock Bucket	1/2"	656 lbs
108420	84" Extreme Duty Rock Bucket	1/2"	690 lbs
108425	96" Extreme Duty Rock Bucket	1/2"	775 lbs



FEATURES INCLUDE

- 3" spacing between tines
- Available in 60", 72", 78", 84", and 96" widths
- 3/8" Thick tines
- Available with Euro/Global mount

SNOW & MULCH BUCKET

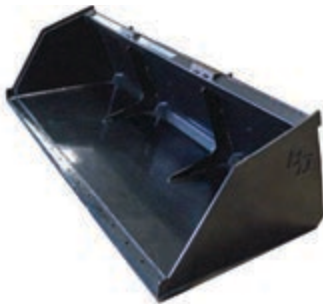

STANDARD / HEAVY DUTY

FEATURES INCLUDE

- 26" high-back bucket, 38" bottom
- Available in 3/16" or 1/4"
- High-capacity sides
- Pre-drilled for bolt-on edge

See pages 29-30 for all Snow and Mulch Bucket Models



HIGH-BACK SNOW & MULCH

FEATURES INCLUDE

- 32" high-back bucket, 38" bottom
- Mesh back increases visibility
- Ribs inside strengthen floor and back
- Pre-drilled for bolt-on edge
- 3/16" material

TRACTOR BUCKET

Blue Diamond® offers several styles of buckets to fit most any application you may encounter with a tractor. Our bolt-on cutting edges and tooth bars fit any of these buckets to adapt them into the perfect tool to use wherever you might need them.

FEATURES INCLUDE

- Heavy duty construction
- 3/4" x 6" cutting edge
- Rolled back for easy clean out
- Bolt-on edge or toothbar available



PART NUMBER	MODEL	STRUCK CAPACITY	WEIGHT
108825	60" Tractor Bucket, Smooth	14.4 CU FT	375 lbs
108830	66" Tractor Bucket, Smooth	15.8 CU FT	400 lbs
108835	72" Tractor Bucket, Smooth	17.2 CU FT	420 lbs
108840	78" Tractor Bucket, Smooth	18.7 CU FT	460 lbs
108845	84" Tractor Bucket, Smooth	20.1 CU FT	490 lbs

4' STANDARD DUTY CUTTER

The Blue Diamond® Rotary Cutter is designed for standard duty applications such as weeds, grass, and light brush up to 1 1/2" diameter. This cutter is designed to work with 15 hp to 45 hp tractors, and are available in a 48" width. This cutter uses a single spindle with two free-swinging blades, which reduce the shock of impact when a stationary object is contacted. A standard slip clutch protects the gearbox and driveline from damage. Standard equipment includes driveline, shields, clutch shields, and front and rear chains.



PART NUMBER	403010
MODEL	4'
HORSEPOWER	15-45
WIDTH	48"
WEIGHT	538 lbs
CUTTING CAPACITY	1.5"
DECK THICKNESS	11 Gauge
SIDE BANDS	7"
PTO DRIVE SHAFT	Series 4
STUMP JUMPER	PAN
GEARBOX	55 hp
WHEEL	Laminated
HUB	Greasable
HITCH	Category 1
GEARBOX WARRANTY	5-year limited
CHAIN GUARDS	Standard

FEATURES INCLUDE

- Fully welded gearbox channel and deck
- Replaceable wear skids
- Front/rear chain discharge shield
- 5-year limited gearbox warranty
- 2-year warranty



ROUND BACK CUTTER

HEAVY DUTY

The Blue Diamond® Heavy Duty Round Back Cutter is designed for heavy duty applications such as thick weeds and grass and brush up to 2 1/2" or 3" diameter, depending on the model. These cutters use a single spindle with two free-swinging blades, which reduce the shock of impact when a stationary object is contacted. A slip clutch protects the gearbox and driveline from damage. Standard equipment includes driveline shields and clutch shields.



FEATURES INCLUDE

- Fully welded cutter deck
- Heavy duty round back design
- 2 1/2"–3" cutting capacities
- 5-year limited gearbox warranty
- Fully welded cutter gears 1/2" thick
- Replaceable wear skids
- Front chain and rear chain discharge shields
- 2-year warranty

PART NUMBER	403110	403115	403120
MODEL	5'	6'	7'
HORSEPOWER	35–80	40–80	55–95
WIDTH	60"	72"	84"
WEIGHT	745 lbs	900 lbs	1,305 lbs
CUTTING CAPACITY	3"		
DECK THICKNESS	10 Gauge		
SIDE BANDS	7"		8"
PTO DRIVE SHAFT	Series 4		Series 6
STUMP JUMPER	1/2" Plate		
GEARBOX	100 hp		150 hp
TAILWHEEL	1		
WHEEL	Laminated		
HUB	Bearing		
HITCH	Category 1		Category 2
GEARBOX WARRANTY	5-year limited		
CHAIN GUARDS	Standard		

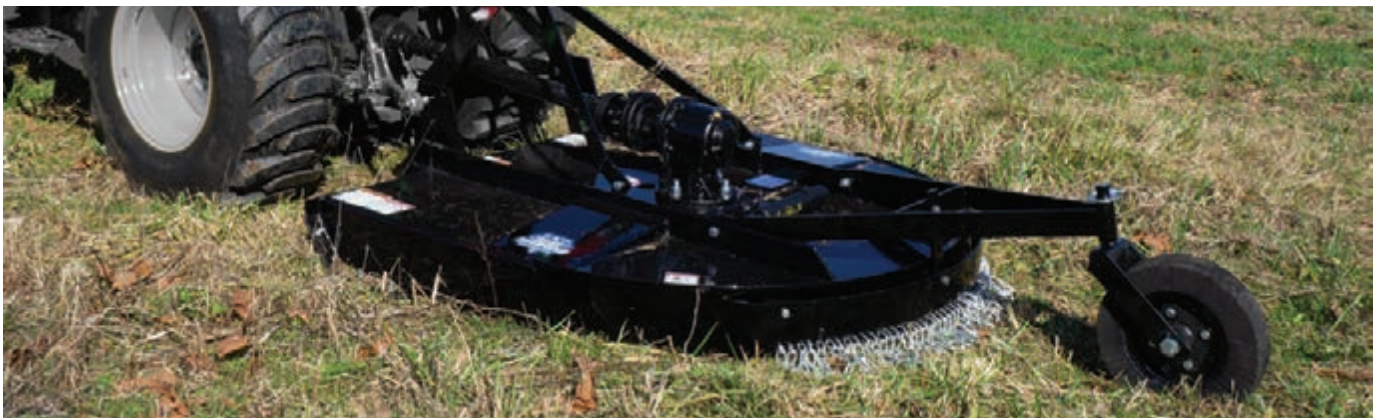

DUAL SPINDLE CUTTER

LIFT TYPE - HEAVY DUTY

The Blue Diamond® Lift Type Heavy Duty Dual Spindle Cutter is designed for heavy duty applications, such as thick weeds and grass and brush up to 3” diameter. The cutter uses dual spindles with 2 free-swinging blades each, which reduces the shock of impact when a stationary object is contacted.



PART NUMBER	403125	403127
MODEL	8'	10'
MIN. HORSEPOWER	42	52
CUTTING WIDTH	94"	117"
TRANSPORT WIDTH	98"	122"
HITCH	Lift Type	
CUTTING HEIGHT	2"-10"	
MAX. CUTTING CAPACITY	3"	
DECK THICKNESS	10 Gauge	7 Gauge
SIDE BANDS	8"	
PTO DRIVE SHAFT	Series 5 w/ Slip Clutch	
CENTER DRIVE SHAFT	Shock Coupler Protected	
STUMP JUMPER	5/8" Plate	
CENTER GEARBOX	125 hp	
OUTBOARD GEARBOXES	100 hp	
WHEEL	Laminated	
HUB	Greasable	
WEIGHT	1,250 lbs	1,405 lbs
SKID SHOES	Replaceable	
GEARBOX WARRANTY	5-year limited	
CHAIN GUARDS	Standard	

FEATURES INCLUDE

- Fully welded cutter deck and gearbox channel
- Heavy duty round back design
- 5-year limited gearbox warranty
- Fully welded cutter gears 1/2” thick
- Replaceable wear skids
- Compact dual spindle design
- Slip clutch protection/dual couplers and front/ rear chain discharge shields are standard
- 2-year warranty



FLEX PROTECTION



CUTTING HEIGHT ADJUSTMENT



DUAL SPINDLE CUTTER

PULL TYPE - HEAVY DUTY

FEATURES INCLUDE

- Pull type hitch with hydraulic rear wheels
- Compact dual spindle design
- 3" diameter cutting capacity
- Slip clutch protection, dual shock couplers, and front/rear chain discharge shields are standard
- Laminated flat-proof wheels
- 2-year warranty



DUAL ADJUSTMENT LEVELING



FLAT-PROOF TIRES



HOSES INCLUDED

PART NUMBER	403129	403130
MODEL	8'	10'
MIN. HORSEPOWER	42	52
CUTTING WIDTH	94"	117"
TRANSPORT WIDTH	98"	122"
HITCH	Pull Type	
CUTTING HEIGHT	2"-10"	
MAX. CUTTING CAPACITY	3"	
DECK THICKNESS	10 Gauge	7 Gauge
SIDE BANDS	8"	
PTO DRIVE SHAFT	Series 6 w/ Slip Clutch	
CENTER DRIVE SHAFT	Shock Coupler Protected	
STUMP JUMPER	5/8" Plate	
CENTER GEARBOX	125 hp	
OUTBOARD GEARBOXES	100 hp	
WHEEL	Laminated	
HUB	Greasable	
WEIGHT	1,575 lbs	1,705 lbs
SKID SHOES	Replaceable	
GEARBOX WARRANTY	5-year limited	
CHAIN GUARDS	Standard	



12' & 15' FLEX-WING ROTARY CUTTER



FLAT-PROOF TIRES



WING LOCKOUT



RATCHET LEVEL ADJUSTMENT

TRACTOR
ATTACHMENTS



12' FLEX-WING

FEATURES INCLUDE

- Smooth top deck design
- Protected gearboxes and drivelines
- Debris discharge safety chains
- 6 free-swinging blades
- Storage for jack stand when not in use
- Single-circuit hydraulics; only 1 hose connection required
- Single-spring suspension
- 144" cutting width
- 4 flat-free tires
- 2-year warranty



15' FLEX-WING

FEATURES INCLUDE

- Protected gearboxes and drivelines
- Debris discharge safety chains
- 6 free-swinging blades
- Storage for jack stand when not in use
- Easy adjustment leveling with ratchet
- Triple-spring suspension
- 180" cutting width
- 6 flat-free tires
- 2-year warranty

ATTACHMENT SPECS ON
NEXT PAGE

12' & 15' FLEX-WING ROTARY CUTTER



12' FLEX-WING

15' FLEX-WING

PART NUMBER	403150
MODEL	12'
MIN. HORSEPOWER	35 hp (Gear-Drive Trans)
HITCH	Swivel Clevis
DECK THICKNESS	10 Gauge
DECK HEIGHT	11"
SIDE SKIRT MATERIAL	3/16"
HINGE RODS	1"
SUSPENSION	Single Spring
OUTBOARD GEARBOX	75 hp
SPLITTER GEARBOX	175 hp
GEARBOX	540 RPM
BLADES	1/2" x 3" w/ lift
BLADE TIP SPEED	15,657 FPM
BLADE OVERLAP	6"
BLADE CARRIERS	3/16" Formed Plate w/ 3/4" x 6" Blade Bar
CUTTING WIDTH	144"
OVERALL WIDTH	151"
OVERALL LENGTH	158"
TONGUE WEIGHT	759 lbs
OVERALL WEIGHT	2,630 lbs
CUTTING HEIGHT	1 1/2"–12"
CUTTING CAPACITY	Up to 2"
INPUT PTO	ASAE Category 5 Constant Velocity
WING DRIVE PTO	ASAE Category 4 w/ Slip Clutch
SKID SHOES	Replaceable
CHAIN SHIELDS	Single Row/Standard
TOWING SAFETY CHAINS	Standard
GEARBOX WARRANTY	5-year limited
WHEEL TYPE	5-Lug Laminated Standard

PART NUMBER	403155
MODEL	15'
MIN. HORSEPOWER	55 hp
HITCH	Swivel Pivot
DECK THICKNESS	10 Gauge
BODY DEPTH	9 1/2"
SIDE SKIRT MATERIAL	1/4" x 13 1/2"
UNDERNEATH DECK	Heavily Braced
OUTBOARD GEARBOX	190 hp
SPLITTER GEARBOX	235 hp
GEARBOX	540 RPM (1,000 optional)
BLADES	1/2" x 4"
BLADE TIP SPEED	17,135 FPM
BLADE OVERLAP	6"
BLADE CARRIERS	3/16" Formed Plate w/ 5/8" x 10" x 23" Blade Bar
CUTTING WIDTH	15'
OVERALL WIDTH	188"
OVERALL LENGTH	189"
OVERALL WEIGHT	5,175 lbs
CUTTING HEIGHT	2"–15"
CUTTING CAPACITY	3 1/2"
INPUT PTO	ASAE Category 6
WING DRIVE PTO	ASAE Category 4
SKID SHOES	Replaceable
CHAIN SHIELDS	Standard
TOWING SAFETY CHAINS	Standard
GEARBOX WARRANTY	5-year limited
WHEEL TYPE	5-Lug Laminated Standard

PART NUMBERS	403157	403158
WHEEL TYPE	Aircraft tires	Aircraft tires w/ LED lights

DISC HARROW

The Blue Diamond® Disc Harrow is for medium duty usage with notched discs that easily break up and redistribute cultivated topsoil. It will certainly meet the needs of commercial landscapers, larger nurseries and gardens, as well as small farms. Accepts a Category 1 quick hitch.



PART NUMBER	445010	445015	445020
MODEL	5'	6'	7'
HORSEPOWER	30-40	35-45	40-60
CUTTING WIDTH	60"	72"	84"
WEIGHT	577 lbs	700 lbs	780 lbs
NUMBER OF DISC BLADES	16	20	24
DISC BLADE SIZE	18"		
DISC BLADE SPACING	7 1/2"		
BEARINGS	Sealed		
QUICK-HITCH COMPATIBLE	Yes		
HITCH	Category 1		

FEATURES INCLUDE

- Sealed bearings for long life
- Heavy duty tube frame construction
- 2-year warranty

FINISHING MOWER

The Blue Diamond® Finishing Mower suits 20 hp to 60 hp tractors with a Category 1 hitch and can be used in front of or behind the tractor. The finishing mower will make your land look sharp with fine and controlled cuts in small to medium grass, thanks to its 3 blades.



PART NUMBER	403510	403515	403520	403525
MODEL	4'	5'	6'	7'
OVERALL WIDTH	52"	65"	76"	89"
WORKING WIDTH	48"	60"	72"	84"
TRACTOR HP RANGE	20-50	25-50	30-50	35-60
CUTTING HEIGHT	1"-4"			
3-POINT HITCH TYPE	Category 1			
NUMBER OF BLADES	3			
PTO INPUT SPEED	540 rpm			
DECK THICKNESS	7 Gauge			
PTO SHAFT TYPE	Series 4			
WEIGHT W/OUT PTO	529 lbs	440 lbs	590 lbs	720 lbs
BELTS	2			
FRONT ROLLER	Standard			

FEATURES INCLUDE

- Usable on front or rear of tractor
- Quickly converts tractor to turf maintenance
- 2-year warranty

FLAIL MOWER

The Blue Diamond® Flail Mower is suitable for tractors from 40 hp to 100 hp. The Standard Duty fits Category 1 hitches and the Heavy Duty fits Category 2. The flails or hammers allow them to mow grass and brush up to 1 1/2" thick. Both models feature hydraulic side shift, rear roller, and rakes.



FEATURES INCLUDE

- Multi-purpose for grass and brush
- 1 1/2" diameter brush capacity
- Dual tapered bearing design for easy adjustment
- Minimum tractor weight of 2,000 lbs
- Counterweight recommended
- Hydraulic side shift
- Rear anti-scalp roller
- 2-year warranty

STANDARD DUTY

PART NUMBER	403710	403720	403730
SIZE	69"	81"	87"
OVERALL WIDTH	69"	75.5"	87.4"
MOWING WIDTH	63"	69"	80.7"
TRACTOR HP RANGE	35-70	40-70	45-70
3-POINT HITCH TYPE	Category 1		
HYDRAULIC OFFSET	12"		
NUMBER OF HAMMERS	20	22	26
WEIGHT W/OUT PTO	1,100 lbs	1,120 lbs	1,160 lbs
BELTS	4		

HEAVY DUTY

PART NUMBER	403740	403750
SIZE	87"	98"
OVERALL WIDTH	96"	106"
WORKING WIDTH	87"	98"
TRACTOR HP RANGE	50-100	
3-POINT HITCH TYPE	Category 2	
HYDRAULIC OFFSET	15"	
NUMBER OF HAMMERS	20	24
NUMBER OF BLADES	60	72
ROLLER DIAMETER	6.69"	
ROTOR DIAMETER	6.69"	
WEIGHT W/OUT PTO	1,730 lbs	1,840 lbs
BELTS	4	5

TRACTOR GRAPPLE

The Blue Diamond® Tractor grapple was designed to fill a gap in the market where a quality grapple was needed at an economical price. With dual independent cylinders and constructed on 1/2" steel, this grapple is sure to meet all your needs for general purpose tasks and light land clearing.



FEATURES INCLUDE

- 1" thick steel end tines
- 8" spacing between tines
- Opens to 42"
- Available with universal skid steer, Euro-Ag/Global, or JD 400/500 mounts

- Hoses included with 1/2" flat face couplers
- OEM colors available

PART NUMBER	107204	107207	107210
MODEL	60"	66"	72"
WEIGHT	727 lbs	756 lbs	725 lbs

GRAPPLES



Light Duty Root Grapple

FEATURES INCLUDE

- Dual independent clamps
- 3/8" steel
- Greasable 1" pivot pins
- 1-piece tines
- Flat-face couplers included
- Opens to 30"



Light Duty Grapple Bucket

FEATURES INCLUDE

- 3/8" steel
- Dual independent clamps
- Greasable 1" pivot pins
- Flat-face couplers included
- Opens to 30"



Heavy Duty Grapple Rake

FEATURES INCLUDE

- 3/8" steel
- Dual cylinders
- Greasable 1" pivot pins
- Flat-face couplers included
- Opens to 30"



Heavy Duty Root Grapple

FEATURES INCLUDE

- 1/2" thick top clamps
- Cylinder protection covers
- Opens to 32"
- Best for machines up to 50HP or 1800 lb lift capacity



Heavy Duty Grapple Bucket

FEATURES INCLUDE

- Laser-cut cutting edge gussets on tips of tines with 3" spacing
- Works great as a land plane and for light clearing



Heavy Duty Rock Bucket Grapple

FEATURES INCLUDE

- 1/2" top tines
- Centered, protected cylinders
- No-pinch hose routing
- Protected hydraulic lines



Severe Duty Root Grapple

FEATURES INCLUDE

- 1/2", extra strong one-piece tines throughout
- Closed in quick attach area
- Reinforced top clamps
- "No pinch" hose routing



Severe Duty Grapple Bucket

FEATURES INCLUDE

- No-pinch hose routing
- Bolt-on sides
- 3/4" top tines
- Heavily reinforced top clamps



Severe Duty Grapple Rake

FEATURES INCLUDE

- Dual top clamps
- 3/4" tine width
- Replaceable teeth

See pages 38-42 for all Grapple Models

HAY SPEARS

The Blue Diamond® Hay Spear is high quality yet compact. It is available in 3 styles: a single spear with standard or heavy duty stabilizers for round bales, a double bottom and a quad bottom style for large square bales, which can also be used as a pallet fork. The high-quality German-made spear tines are rated for 3,500 lbs each, and the lower stabilizers are replaceable. These strong frames are powder coated, and a bolt-on back rack is available.

All of our hay spears carry a 1-year warranty with a 2-year warranty on tines.



PART NUMBER	MODEL	SPEAR LENGTH	WEIGHT
311003	Hay Spear W/ HD Stabilizers	36"	154 lbs
311006	Hay Spear W/Standard Stabilizers	48"	165 lbs
311007	Hay Spear W/Standard Stabilizers & Back Rack	48"	204 lbs
311008	Hay Spear W/ HD Stabilizers	48"	160 lbs
311009	Double Bottom Hay Spear (Short Spears)	36"	180 lbs
311010	Double Bottom Hay Spear	48"	214 lbs
311011	Double Bottom Hay Spear W/Rack	48"	218 lbs
311040	Double Top Tine Hay Spear W/Bottom Stabilizers	48"	180 lbs
311045	Quad Bottom Hay Spear, 45" Wide	48"	280 lbs
311050	Quad Bottom Hay Spear, 60" Wide	48"	262 lbs
311060	Quad Bottom Hay Spear, 75" Wide	48"	304 lbs
311405	3 pt. Tractor Hay Spear, Category 1 Mount	49"	86 lbs
311408	3 pt. Tractor Hay Spear, Category 2 Mount	49"	128 lbs

High-quality tines, removable stabilizers, Euro-Ag/Global, and John Deere mounts available. Double spears are spaced at 30".

MOUNT PLATE

Make your own attachment or make your old attachments fit your new skid steer. Mounts available to fit to all universal hitch machines, John Deere 400/500, and Euro-AG. Made from 1/4" or 1/2" thick solid plate.

PART NUMBER	MOUNT	THICKNESS	WEIGHT
113005	Universal Skid Steer	1/4"	75 lbs
113005-14	JD 400/500	1/4"	54 lbs
113005-16	Euro-AG	1/4"	55 lbs
113006	Universal Skid Steer	1/2"	140 lbs



PALLET FORKS

Blue Diamond® Pallet Forks are some of the most used attachments, next to a bucket, and must be built well. Being able to see your tines is an important consideration, and all Blue Diamond® frames have excellent visibility. We offer pallet forks from 2,000 lbs to 6,000 lbs capacity with a variety of tine lengths.



Heavy Duty Pallet Fork



HD Extra Large Pallet Fork



Block & Brick Pallet Fork HD

TRACTOR ATTACHMENTS



Light Duty Pallet Fork



Heavy Duty with D-Ring Pallet Fork



Heavy Duty Hydraulic Pallet Fork



Standard Duty Pallet Fork



Wide-Frame Heavy Duty Pallet Fork



Grapple Pallet Fork

See pages 35-37 for all Pallet Fork Models

MOLDBOARD PLOW

The Blue Diamond® Moldboard Plows come in single bottom and double bottom models, designed for tractors ranging from 18 hp to 50 hp. Both models are our basic moldboard plow, best suited for gardens, nurseries, hobby farms, and wild game food plots. They are designed to turn over and aerate the soil for primary tillage and to bury residue. Both are available in single or double 16" plowshare lengths with replaceable plowshares and are shear-bolt protected and compatible with a Category 1 hitch.

FEATURES INCLUDE

- 16" plowshare length
- Replaceable share and moldboard
- 2-year warranty

PART NUMBER	440012	440010	440015
MODEL	14" (single)	16" (single)	16" (double)
WEIGHT	188 lbs	205 lbs	348 lbs



SINGLE BOTTOM



DOUBLE BOTTOM

POWER RAKE HEAVY DUTY SERIES 2

This Heavy Duty Series 2 Power Rake follows close on the heels of our previously released Severe Duty model. This lighter unit is suited to smaller compact tractors with a Category 1 hitch.

PART NUMBER	MODEL	WEIGHT
432402	48" Power Rake, HD, Replaceable Teeth	690 lbs
432401	48" Power Rake, HD, Fixed Teeth	690 lbs
432404	60" Power Rake, HD, Replaceable Teeth	850 lbs
432403	60" Power Rake, HD, Fixed Teeth	750 lbs
432409	72" Power Rake, HD, Replaceable Teeth	825 lbs
432405	72" Power Rake, HD, Fixed Teeth	825 lbs
332760	Power Rake HD, 3 pt. Hitch Hydraulic Angle Kit w/60" long hoses	—
332765	Power Rake HD, 3 pt. Hitch Hydraulic Angle Kit w/84" long hoses	—



HYDRAULIC ANGLE KIT SHOWN ATTACHED

Select base model, mount and hydraulic kit



REVERSIBLE SIDE SHIELD



FLIP UP WHEELS



HEAVY DUTY PROTECTED BEARING

POWER RAKE EXTREME DUTY

When productivity matters, look no further. Travel faster, cut deeper, and get on to the next job! With skid steer machine sizes increasing in the industry, there is a need for a more powerful and durable power rake/soil conditioner attachment. The Blue Diamond® Extreme Duty Power Rake is designed to power through jobs where others fail, and is set up for simple servicing. This massive 6,000 series motor and optimal drum size produce maximum torque, and the motor is kept out of the way, maximizing usable width in tighter areas. The aggressive 2” teeth are ideal for leaving a fresh seed bed with fewer passes.



PART NUMBER	MODEL	WEIGHT
432105	72” Power Rake, Replaceable Teeth	1,217 lbs
432107	72” Power Rake, Fixed Teeth	981 lbs
432110	84” Power Rake, Replaceable Teeth	1,124 lbs
432112	84” Power Rake, Fixed Teeth	1,155 lbs
432115	96” Power Rake, Replaceable Teeth	1,685 lbs
432117	96” Power Rake, Fixed Teeth	1,310 lbs
332735	Power Rake HD, 3 pt. Hitch Hydraulic Angle Kit w/60” long hoses	25 lbs
332740	Power Rake HD, 3 pt. Hitch Hydraulic Angle Kit w/84” long hoses	25 lbs



POWER RAKE SEVERE DUTY WITH 3 PT. HITCH

The Blue Diamond® Severe Duty Power Rake for tractors is designed to succeed in conditions where others start failing – structurally and mechanically, and is set up for simple servicing. With the same frame design as our proven Severe Duty model for skid steers, this unit features a Category 2 hitch and a PTO drive to power the drum. The optional hydraulic angle kit is a great accessory that allows you to angle the unit from the operator’s seat.



PART NUMBER	432005	432007	432007	432007	432015	432017
TEETH	Replaceable	Fixed	Replaceable	Fixed	Replaceable	Fixed
WORKING WIDTH (STRAIGHT)	72"	72"	84"	84"	96"	96"
WORKING WIDTH (ANGLED)	66"	66"	78"	78"	90"	90"
OVERALL WORKING WIDTH (STRAIGHT)	82"	82"	94"	94"	106"	106"

LANDSCAPE RAKE

STANDARD DUTY

The Blue Diamond® Standard Duty Landscape Rake works well for cleaning and preparing sites for seeding. It can spread rocks, move debris, and reshape soil. Designed for use by landscapers and contractors, it will meet the demands required for golf course maintenance, terracing hillsides, shaping run-off control ditches, and preparing areas for reforestation.



PART NUMBER	433010	433015	433020	433025	433030
MODEL	4'	5'	6'	7'	8'
HORSEPOWER	15-45	20-45	25-45	30-45	35-45
TINES/FOOT	6 per ft				
WORKING WIDTH	48"	60"	72"	84"	96"
WEIGHT	174 lbs	198 lbs	224 lbs	251 lbs	281 lbs
A-FRAME MATERIAL	3/8"				
MAINFRAME	4" x 4" Angle				
ANGLE ADJUSTMENT	5-Position, Forward and Reverse				
HITCH	Category 1 & 3 Point				

FEATURES INCLUDE

- 5-position angle adjustment
- Category 1 hitch & 3 Point
- Quick hitch compatible
- 2-year warranty



ROTOTILLER

The Blue Diamond® Heavy Duty Rototiller is designed and manufactured for many years of dependable use. Designed to work with 20 hp to 65 hp tractors. With a gear-drive transmission and 6 tines per flange, you can till 8" deep. A standard slip clutch protects the gearboxes and driveline from damage.



FEATURES INCLUDE

- Available in 48", 60", 72", and 84" widths
- 8" cutting depth
- Heavy duty gear-drive system
- 2-year warranty



ADJUSTABLE HITCH FOR CATEGORY 1 AND CATEGORY 2



DEPTH ADJUSTMENT



SPRING TENSIONED SMOOTHER

PART NUMBERS	429010	429015	429020	429030
HORSEPOWER	20-35	25-40	35-50	50-65
WIDTH	48"	60"	72"	84"
WEIGHT	440 lbs	650 lbs	762 lbs	1,033 lbs
DRIVE TYPE	Heavy Duty Gear Driven			
FLANGES	6	7	9	9
NUMBER OF TINES	24	42	54	54
DEFLECTOR	Rear Hinged			
DRIVELINE	Heavy Duty Slip Clutch			
HITCH	CAT 1	CAT 1	CAT 1	CAT 1/2
QUICK-HITCH COMPATIBLE	Yes			
GEARBOX WARRANTY	1-year limited			

SILT FENCE INSTALLER

3 POINT HITCH

The Blue Diamond® Silt Fence Installer is essential for erosion control. Easily install silt fencing in a fraction of the time. The design allows a trench to be cut and installs the fence up to 20” deep without needing to pre-trench and backfill.

Two models are available to best suit your application; a fixed center mount fits most applications, or a sliding offset mount for installation near buildings or other structures.

FEATURES INCLUDE

- Trench and install fencing in one pass
- 40° pivot to either side of center for turning
- Fits up to 30” diameter roll
- Spring loaded coulter easily cuts through trash, roots and other debris
- Installs up to 20” deep
- Fits 36”, 42”, and 48” tall fencing
- Sliding offset mount allows for installation next to buildings/structures
- Install thousands of feet of fencing per hour



PART NUMBER	MODEL	WEIGHT	DIMENSIONS
475015	Fixed, Center Mount	760 LBS	41”W x 78”L x 70”H
475020	Sliding Offset, 84” Wide	1,165 LBS	84”W x 89”L x 70”H

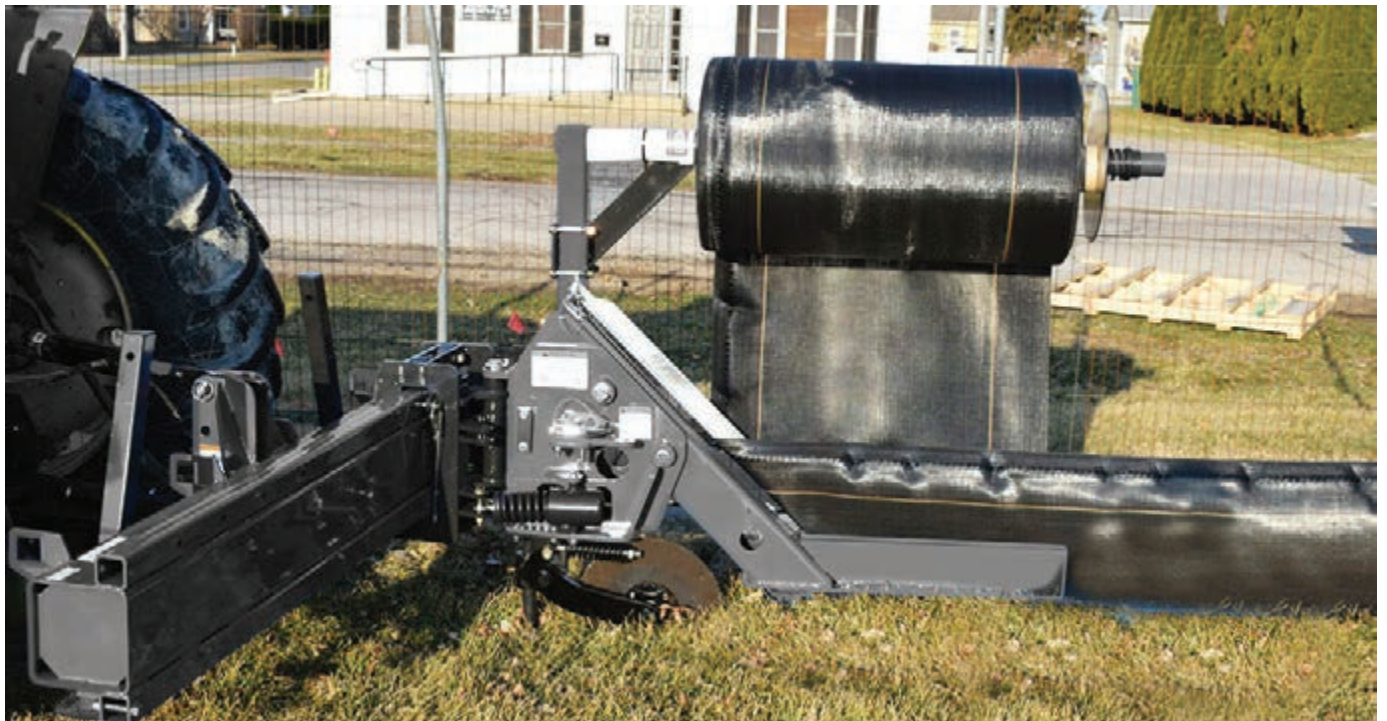

AUTOWING SNOW PLOW

Move more snow with a snow plow that thinks for itself - the Blue Diamond® Autowing Snow Plow. Its mechanical wings automatically adjusting from scoop mode to windrow position as you angle the plow allowing multiple angles to add torsional strength and prevent twisting under heavy loads. By combining the ease of straight blade operation with the productivity of a winged snow plow, the Blue Diamond® Auto Wing Snow Plow clears big jobs fast to ensure quality and consistency on every plow.



FEATURES INCLUDE

- 103" width
- 29" blade height
- Side wings adjust automatically
- Full-trip moldboard
- Steel cutting edge
- Hydraulic angle
- 6° oscillation to follow ground contour



FULL-TRIP MOLDBOARD



FULLY ANGLED BLADE

PART NUMBER	STRAIGHT WIDTH	ANGLED WIDTH	ANGLE	COUPLERS	MOUNT	SIDE MARKERS	CYLINDERS
120720	103"	93.4°	25°	1/2" Flat Face	Universal Skid Steer	Yes	2

SNOW BLADE HEAVY DUTY SERIES 2 MULTI-PURPOSE

The Blue Diamond® Heavy Duty Series 2 Multi-Purpose Blade is designed for commercial contractors. At 28" tall, this blade is purpose-built for large applications and has an optional 8" height extension that can be bolted on for even more capacity. The curved back keeps the material rolling for maximum efficiency. Adjustable skid shoes allow the cutting edge to land perfectly every time. The full-trip moldboard protects the operator and equipment from hidden obstacles or curbs. These blades have a trip-lockout pin that can be installed when using the blade for dirt applications.



FEATURES INCLUDE

- Available in 84", 96", 108", and 120" widths
- 28" blade height
- Optional bolt-on 8" height extension
- Full-trip moldboard
- Steel cutting edge
- Hydraulic angle

PART NUMBER	STRAIGHT WIDTH	ANGLED WIDTH	ANGLE	HEIGHT	WEIGHT
123470	84"	72 1/2"	30°	28"	901 lbs
123475	96"	83"	30°	28"	946 lbs
123480	108"	93"	30°	28"	986 lbs
123485	120"	104"	30°	28"	1,016 lbs

SNOW BLADE STANDARD DUTY SERIES 2 MULTI-PURPOSE

The Blue Diamond® Standard Duty Series 2 Multi-Purpose Blade is great for snow and light dirt work. At 22" tall, this blade is a great fit for most users and has an optional 8" height extension that can be bolted on for high-volume applications. The curved back keeps the material rolling for maximum efficiency. Adjustable skid shoes allow the cutting edge to land perfectly every time. The full-trip moldboard protects the operator and equipment from hidden obstacles or curbs. These blades have a trip-lockout pin that can be installed when using the blade for dirt applications.



SHOWN WITH OPTIONAL HEIGHT EXTENSION

PART NUMBER	STRAIGHT WIDTH	ANGLED WIDTH	ANGLE	HEIGHT	WEIGHT
123415	72"	62 1/4"	30°	22"	590 lbs
123420	84"	72 1/2"	30°	22"	620 lbs

FEATURES INCLUDE

- Available in 72" and 84" widths
- 22" blade height
- Optional bolt-on 8" height extension
- Full-Trip moldboard
- Steel cutting edge
- Hydraulic angle

SNOW PUSHER

The Blue Diamond® Snow Pusher is great! It uses a rolled moldboard to keep the snow rolling and reduce the horsepower required to move the snow. The bolt-on wear shoes are made from AR400 steel with excellent wear resistance. The basic design and profile are the same between the standard and heavy duty models, but the heavy duty uses more crosstubes and braces for commercial use.



STANDARD DUTY

PART NUMBER	120310	120111	120113	120115
SIZE	48"	60"	72"	96"
WEIGHT	403 lbs	625 lbs	650 lbs	835 lbs
HEIGHT	35"	35"	35"	35"

HEAVY DUTY

PART NUMBER	120135	120150	120155
SIZE	72"	96"	120"
WEIGHT	686 lbs	770 lbs	839 lbs
HEIGHT	35"	35"	35"



SOD ROLLER



The Blue Diamond® Sod Roller makes laying large sod rolls simple. Slide the roller shaft through the center of the roll, then pick it up with the attachment and roll sod out. The sod roll can be mounted to roll out while driving either forward or in reverse.



ADJUSTABLE WIDTH MODEL



FIXED WIDTH MODEL



FEATURES INCLUDE

- 36", 42", and 50" models
- Fixed and adjustable width models

PART NUMBER	MODEL	WEIGHT
102200	36" Sod Roller with 40" Arms	225 lbs
102205	42" Sod Roller with 40" Arms	240 lbs
102215	50" Sod Roller with 40" Arms	255 lbs
302305	Adjustable, 36" - 48" Wide Roll	280 lbs

TRAILER SPOTTER



The Blue Diamond® Trailer Spotter is a great tool for moving trailers in tight areas with your tractor. Accepts 2" trailer hitch.

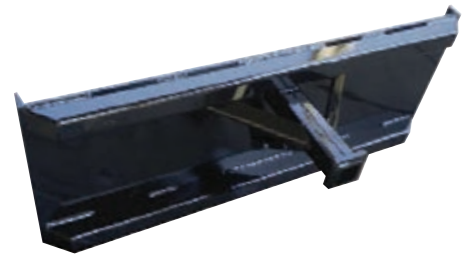

FEATURES INCLUDE

- 3,500 lbs capacity full-size version
- Also able to accept salt/seed spreader
- Many mounts available
- Accepts 2" trailer hitch

PART NUMBER	MODEL	WEIGHT
112010	Trailer Spotter, Skid Steer Mount	118 lbs



TREE BOOM

The Blue Diamond® Tree Boom is designed for setting new trees or moving cut trees. The 3,500 or 5,000 lb capacity makes this attachment useful in many applications.

FEATURES INCLUDE

- 3,500 lbs or 6,000 lbs capacity
- Made from heavy duty tubing
- Hole for mounting a chain, strap, or our optional clevis with hook



3,500 LB CAPACITY



HEAVY DUTY SERIES 2
5,000 LB CAPACITY

PART NUMBER	MODEL	WEIGHT
112005	Tree Boom, 3,500 Lift Cap	3,500 lbs
112003	Tree Boom, HD, Series 2,5,000 Lift Cap	5,000 lbs
212050	Optional Clevis W/Swivel Hook	4 lbs

TREE PULLER

The Blue Diamond® Tree Puller is an excellent tool for removing small trees and shrubs when the roots need to be pulled out. The serrated teeth lock onto the base of the tree, then pry or pull roots and all from the ground, shake the dirt out of the roots, and carry removed tree or shrub to where you want to stack your material. The heavy duty version has 2 rows of teeth for added grip.



HEAVY DUTY



STANDARD DUTY

FEATURES INCLUDE

- HD has protected cylinder
- Heavily gusseted quick attach
- Opens to 11"
- Available in Standard and Heavy Duty
- 1-year warranty

PART NUMBER	MODEL	WEIGHT
127006	Tree & Post Puller, Standard Duty	291 lbs
127010	Tree & Post Puller, Heavy Duty	415 lbs





AUGER DRIVE

Blue Diamond® Attachments is known for its reliability and quality, especially in the auger drives. This mini auger drive exceeds all industry standards with a 4-year warranty. Available to fit most mini-walk behind skid steers and compact track loaders.

FEATURES INCLUDE

- 2" hex shaft
- Double swing action
- Lifetime shaft pull-out warranty,
- 5-year planetary drive warranty
- 3-year hydraulic motor warranty
- 1-year mount and mount components warranty



MS1

PART NUMBER	MODEL	WEIGHT	HEX SHAFT
105700	MS1 2-Way	136 lbs	2"
105702	MS1 4-Way	145 lbs	2"
305706	EX1, 8-11 GPM	165 lbs	2"
305709	EX2, 12-16 GPM	188 lbs	2"
305713	EX3, 17-20 GPM	195 lbs	2"
305716	EX4, 29-23 GPM	195 lbs	2"

Part numbers listed are not machine specific. Specify which mount is needed.

BACKHOE

The Blue Diamond® Mini Backhoe will take a serious beating! Because of its design for heavy use, this attachment is engineered to out perform all backhoes in its class.

FEATURES INCLUDE

- 42" or 48" long with 8", 10", or 12" bucket
- Pivot linkage increases bucket rotation and breakout force



PART NUMBER	MODEL	WEIGHT
130500	42" Long Mini Hyd, Backhoe Only, Requires Bucket	106 lbs
130505	48" Long Mini Hyd, Backhoe Only, Requires Bucket	113 lbs
130509	8" Mini Backhoe Bucket	31 lbs
130512	10" Mini Backhoe Bucket	35 lbs
130515	12" Mini Backhoe Bucket	39 lbs

Part numbers listed are not machine specific. Specify which mount is needed.

BLADES



MINI BLADE

FEATURES INCLUDE

- Manual or hydraulic angle
- 48" & 60" widths
- Trip lockout function for dirt work
- Wear shoes and trip springs for snow use
- Non-marking edge available for delicate surfaces



MINI V-BLADE

FEATURES INCLUDE

- Easy-to-use 9 position angle
- Replaceable cutting edge
- Optional height extender
- Heavy duty main pivot
- Adjustable skid shoes
- Trip lockout
- Mounts available to fit most mini machines

PART NUMBER	MODEL	WEIGHT
123165	48" Multi Purpose	296 lbs
123170	60" Multi Purpose	322 lbs
122305	48" V-Blade, Manual Angle	315 lbs
122310	60" V-Blade, Manual Angle	325 lbs

Part numbers listed are not machine specific. Specify which mount is needed.



HYDRAULIC BREAKER HAMMER

Our 10-year quest to develop a superior hydraulic breaker is now available from Blue Diamond®. This “hammer” design offers technology, simplicity, reliability, ease of setup, and service support. No more downtime! Get started on your demolition, construction, and quarry jobs now.



PART NUMBER	MODEL	MAX OIL FLOW	FREQUENCY (BPM)	OPERATING WEIGHT	TOOL DIAMETER	ENERGY CLASS	CARRIER WEIGHT	(PSI) BACK PRESSURE
135005	HB50	7	1,200	132 lbs	1.5	100	1,500-2,650 lbs	290-360
135009	HB95	11		220 lbs	1.8	200	2,650-4,000 lbs	
135016	HB165	13		370 lbs	2.2	400	4,000-6,600 lbs	
135021	HB210	16	1,100	463 lbs	2.5	500	6,100-9,900 lbs	

Part numbers listed are not machine specific. Specify which mount is needed. Working pressure is 1,750.

FEATURES INCLUDE

- 3-year warranty
- Mono-block design / no tie rods
- Anti-blank firing system hydraulic brake
- No re-gassing needed
- Only 2 internal moving parts
- 2 speed control / variable stroke
- Quiet operation
- Self-regulating
- Body bushings around piston

ROTARY ANGLE BROOMS HEAVY DUTY SERIES 2

The Blue Diamond® Mini Angle Broom is a smaller version of our original angle broom. It still uses the heavy duty bearings, frame and motor. The bidirectional motor allows debris to be swept while moving forward or in reverse. The manual or hydraulic angle is perfect to make sure you put your debris where you want it.

PART NUMBER	MODEL	WEIGHT
116180	36" Hydraulic Angle	495 lbs
116182	36" Manual Angle	495 lbs
116200	48" Hydraulic Angle	564 lbs
116202	48" Manual Angle	564 lbs
116205	60" Hydraulic Angle	760 lbs
116207	60" Manual Angle	760 lbs

Part numbers listed are not machine specific. Specify which mount is needed. Includes Poly/Steel Bristles & requires wire harness.



FEATURES INCLUDE

- 36", 48", or 60" widths
- 26" Bristles
- Poly or poly/steel bristles available
- Manual or Hydraulic angle
- Stands protect bristles when not in use
- 1-year warranty



PICK-UP BROOM

The Blue Diamond® Attachments Mini Pick-up Broom is just as robust as the full size pickup broom, just in a smaller package! The reinforced hood and heavy front bumper protects the bristles from any impact. The greasable bearings and pivot points allow for extra longevity. It is available in 42", 48", and 54" widths with mounts available to fit most machines.



FEATURES INCLUDE

- 18" poly/steel bristles
- Reinforced hood and bumper
- Optional dust suppression water kit
- Adjustable sweeping height
- Mounts available to fit most machines

PART NUMBER	MODEL	WEIGHT
116810	42" Pickup Broom	584 lbs
116815	48" Pickup Broom	655 lbs
116820	54" Pickup Broom	705 lbs

Part numbers listed are not machine specific. Specify which mount is needed.

PUSH BROOM STANDARD & HEAVY DUTY

This incredible broom will amaze you! Clean up job sites, push light snow, sweep leaves, squeegee water, or groom ball fields. Add our heavy duty magnet for picking up screws, nails, and other steel debris. The Standard Duty comes with 8 rows of bristles, and the Heavy Duty has 11 rows of bristles. Models are available in 60", 72", or 96" widths.



FEATURES INCLUDE

- 60", 72", and 96" widths
- 8 or 11 rows of bristles
- Easy to change mount
- Does not require hydraulics

PART NUMBER	MODEL	WEIGHT	BRISTLES
316030	60" Standard Duty Push Broom	271 lbs	8 Rows
316035	72" Standard Duty Push Broom	341 lbs	8 Rows
316040	60" Push Heavy Duty Push Broom	426 lbs	11 Rows
316045	72" Push Heavy Duty Push Broom	459 lbs	11 Rows
316055	96" Push Heavy Duty Push Broom	535 lbs	11 Rows
116020	Forklift Mount (Hd Model Req 116027)	52 lbs	—

Part numbers listed are not machine specific. Specify which mount is needed.

PUSH BROOMS

LIGHT DUTY

The Blue Diamond® Light Duty Push Broom is an economical solution for sweeping. Available in 36", 48", and 60" widths, the Light Duty Push Broom is a great fit for mini skid steers and fork lifts. 5 rows of bristles push dust and debris with ease.

FEATURES INCLUDE

- Bolt-on mount for use with multiple machines
- Mounts available to fit mini skid steers, mini excavators, and forklifts
- 5 rows of bristles
- 36", 48", and 60" widths



PART NUMBER	MODEL	DIMENSIONS	WEIGHT
316010	36" LD Push Broom	36"W x 28"H x 28"D	114 lbs
316015	48" LD Push Broom	48"W x 28"H x 28"D	130 lbs
316020	60" LD Push Broom	60"W x 28"H x 28"D	146 lbs



MINI BRUSH CUTTER SERIES 2



The Blue Diamond® Mini Brush Cutter has top performance in grass and up to 4" brush. With a minimum required flow of 9 GPM, this mini brush cutter can go on almost any machine! The 3 double-sided blades with bi-directional cutting extend the lifespan of your blades and keep you working longer. The exceptionally strong direct drive makes this mini brush cutter a front runner in its class. Choose the open front design to allow for a good bite at the base of trees and shrubs.



OPEN-FRONT

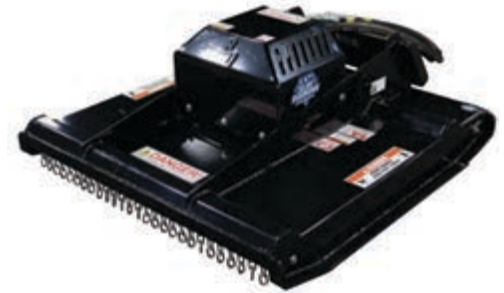

CLOSED-FRONT

PART NUMBER	MODEL	BEST FLOW	WEIGHT
303716	36" Cut, 80cc, Closed Front	9-20 GPM	500 lbs
303728	42" Cut, 80cc, Open Front	12-20 GPM	600 lbs
303722	42" Cut, 80cc, Closed Front	12-20 GPM	600 lbs
303731	50" Cut, 80cc, Closed Front	10-20 GPM	800 lbs

FEATURES INCLUDE

- 3 double-edged blades
- 4" cutting capacity
- Direct Drive with lifetime warranty on the spindle
- Minimum required flow: 9 GPM
- Bidirectional cutting

Mini Universal (-25), Bobcat MT (-26) and Avant (-35) mounts are available for the open and closed front models. Specify which machine that you have. Weights could increase by 50 lbs, depending on the mount.

BUCKETS

MINI 4-IN-1



The Blue Diamond® Mini 4-in-1 Bucket for mini skid steers is modeled after its big brother, our Skid Steer 4-in-1 bucket. With the same durable build and versatility, it's a great tool to have on your mini machine.



FEATURES INCLUDE

- Smooth or with teeth
- 36", 42", 48", or 50" available
- Mounts available to fit most mini skid steers

PART NUMBER	MODEL	STRUCK CAP.	WEIGHT
108755	36" Bucket, 4-In-1, Smooth	4.64 CU FT	355 lbs
108760	42" Bucket, 4-In-1, Smooth	5.59 CU FT	375 lbs
108765	48" Bucket, 4-In-1, Smooth	6.48 CU FT	341 lbs
108766	48" Bucket, 4-In-1, Tooth	6.48 CU FT	356 lbs
108770	50" Bucket, 4-In-1, Smooth	7.7 CU FT	425 lbs

Part numbers listed are not machine specific. Specify which mount is needed.

BUCKETS

MINI DISPENSING BUCKET

The Blue Diamond® Dispensing Bucket is great for flowable material and can be used for anything from feed to concrete! This 1/4-yard model is the perfect size for Mini Skid Steers. The tapered front helps material flow freely and the removeable chute makes cleaning and storage easy!



PART NUMBER	MODEL	WEIGHT
110002-26	1/4 Yard Dispensing Bucket W/ Bobcat Mt Mount	393 lbs
110002-36	1/4 Yard Dispensing Bucket W/ASV RT25	403 lbs
110002-25	1/4 Yard Dispensing Bucket W/ Mini Universal Mount	452 lbs

FEATURES INCLUDE

- Available with 1/4-yard hopper with tapered front
- Splash guard around top lip
- 1-year warranty

MINI FRONT DUMP BUCKET



The Blue Diamond® Front Dump Bucket allows you to load trucks and dumpsters you normally could not reach. You gain up to 43" when fully extended.



PART NUMBER	MODEL	STRUCK CAP.	WEIGHT
108990	36" Bucket, Front Dump	5.89 CU FT	340 lbs
108992	38" Bucket, Front Dump	6.1 CU FT	350 lbs
108994	42" Bucket, Front Dump	7.3 CU FT	360 lbs
108996	44" Bucket, Front Dump	7.43 CU FT	375 lbs
108998	50" Bucket, Front Dump	8.6 CU FT	395 lbs

Part numbers listed are not machine specific. Specify which mount is needed.

FEATURES INCLUDE

- Available widths: 36", 38", 42", 44", or 50"
- Gain up to 43" height
- Single cylinder
- Greasable pivot pins

MINI ROCK BUCKET

The Blue Diamond® Mini Rock Bucket is an excellent multi-purpose bucket! Designed as a sifting bucket for mini skid steers, it does exceptionally well used as a land plane or for light clearing. Move rocks and firewood and leave the dirt behind with this bucket, then rake your ground smooth again when you are done.



PART NUMBER	MODEL	WEIGHT
108305	36" Bucket, Rock	160 lbs
108310	42" Bucket, Rock	175 lbs
108315	48" Bucket, Rock	190 lbs
108317	52" Bucket, Rock	200 lbs
108311	42" w/Grapple	425 lbs
108316	48" w/Grapple	450 lbs

Part numbers listed are not machine specific. Specify which mount is needed. See Page 113 for Rock Bucket w/grapple.

FEATURES INCLUDE

- 3/8" tines throughout
- Great visibility through the back
- Available from 36" to 52" wide
- Available with grapple
- Webbed front edge for raking & smoothing



BUCKETS

MINI LOW-PROFILE - 15"



FEATURES INCLUDE

- 15" back height
- Smooth or Tooth
- Bolt-on edge optional

15" BACK

PART NUMBER	MODEL	STRUCK CAP.	WEIGHT
108005	34" Bucket, Low Profile, 15" Back Smooth	3.83 CU FT	160 lbs
108007	34" Bucket, Low Profile, 15" Back Tooth	3.83 CU FT	135 lbs
108010	36" Bucket, Low Profile, 15" Back Smooth	4.43 CU FT	181 lbs
108015	36" Bucket, Low Profile, 15" Back Tooth	4.43 CU FT	200 lbs
108020	42" Bucket, Low Profile, 15" Back Smooth	5.17 CU FT	225 lbs
108025	42" Bucket, Low Profile, 15" Back Tooth	5.17 CU FT	250 lbs
108030	44" Bucket, Low Profile, 15" Back Smooth	5.42 CU FT	200 lbs
108031	44" Bucket, Low Profile, 15" Back Tooth	5.42 CU FT	269 lbs
108040	48" Bucket, Low Profile, 15" Back Smooth	5.91 CU FT	275 lbs
108045	48" Bucket, Low Profile, 15" Back Tooth	5.91 CU FT	285 lbs
108060	52" Bucket, Low Profile, 15" Back Smooth	6.40 CU FT	195 lbs
108065	52" Bucket, Low Profile, 15" Back Tooth	6.40 CU FT	215 lbs
108070	54" Bucket, Low Profile, 15" Back Smooth	6.12 CU FT	215 lbs
108075	54" Bucket, Low Profile, 15" Back Tooth	6.12 CU FT	215 lbs
108090	60" Bucket, Low Profile, Back Smooth	6.83 CU FT	334 lbs
108095	60" Bucket, Low Profile, Back Tooth	6.83 CU FT	373 lbs
108140	60" Bucket, Low Profile, Long Bottom, Smooth	6.83 CU FT	385 lbs

Part numbers listed are not machine specific. Specify which mount is needed.

BUCKETS

MINI LOW-PROFILE - 20"

FEATURES INCLUDE

- 20" back height
- Smooth or Tooth
- Bolt-on edge optional



20" BACK

PART NUMBER	MODEL	STRUCK CAP.	WEIGHT
108006	34" Bucket, 20" Back Smooth	5.53 CU FT	140 lbs
108012	36" Bucket, 20" Back Smooth	6.14 CU FT	249 lbs
108017	36" Bucket, 20" Back Tooth	6.14 CU FT	249 lbs
108022	42" Bucket, 20" Back Smooth	7.16 CU FT	269 lbs
108027	42" Bucket, 20" Back Tooth	7.16 CU FT	225 lbs
108032	44" Bucket, 20" Back Smooth	7.50 CU FT	275 lbs
108037	44" Bucket, 20" Back Tooth	7.50 CU FT	247 lbs
108042	48" Bucket, 20" Back Smooth	8.19 CU FT	310 lbs
108047	48" Bucket, 20" Back Tooth	8.19 CU FT	276 lbs
108052	50" Bucket, 20" Back Smooth	8.59 CU FT	195 lbs
108057	50" Bucket, 20" Back Tooth	8.59 CU FT	195 lbs
108062	52" Bucket, 20" Back Smooth	8.87 CU FT	300 lbs
108067	52" Bucket, 20" Back Tooth	8.87 CU FT	215 lbs
108072	54" Bucket, 20" Back Smooth	9.29 CU FT	215 lbs
108077	54" Bucket, 20" Back Tooth	9.29 CU FT	215 lbs

Part numbers listed are not machine specific. Specify which mount is needed.



BUCKETS

MINI SNOW & MULCH BUCKET



FEATURES INCLUDE

- Available to fit most mini skid steers
- 34" to 60" widths available
- Reinforced frame
- 22" tall
- D-Ring
- Optional bolt-on cutting edge

PART NUMBER	MODEL	STRUCK CAP.	WEIGHT
108503	34" Bucket, Snow/Mulch, 22" Back	8.51 CU FT	101 lbs
108505	36" Bucket, Snow/Mulch, 22" Back	9.41 CU FT	249 lbs
108510	44" Bucket, Snow/Mulch, 22" Back	11.50 CU FT	275 lbs
108512	48" Bucket, Snow/Mulch, 22" Back	12.09 CU FT	325 lbs
108515	50" Bucket, Snow/Mulch, 22" Back	12.55 CU FT	310 lbs
108517	52" Bucket, Snow/Mulch, 22" Back	13.64 CU FT	331 lbs
108518	54" Bucket, Snow/Mulch, 22" Back	14.09 CU FT	450 lbs
108520	60" Bucket, Snow/Mulch, 3/16" Wrap	15.17 CU FT	450 lbs
108685	44" Bucket, Snow/Mulch, High Back W/Mesh	12.31 CU FT	400 lbs
108690	48" Bucket, Snow/Mulch, High Back W/Mesh	13.5 CU FT	350 lbs
108513	48" Bucket, Snow/Mulch	1 YARD	507 lbs
108612	48" Bucket, Snow/Mulch, 1/4 Wrap	1 YARD	620 lbs
108525	60" Bucket, Snow/Mulch, 3/16"	1 YARD	509 lbs
108625	60" Bucket, Snow/Mulch, 1/4 Wrap, Mini Uni Mount	1 YARD	600 lbs

Part numbers listed are not machine specific. Weight could vary depending on mount.

MINI STUMP BUCKET

The Blue Diamond® Mini Stump Bucket is designed exactly like its big brother, the Extreme Duty Stump Bucket. This incredible tool is like having a crowbar on the front of your machine. Digging stumps is just one job this tough little attachment can do.

FEATURES INCLUDE

- 3 cast pin-on teeth
- Curved bottom
- 42" long
- Serrated teeth on sides
- Largest in its class



PART NUMBER	MODEL	WEIGHT
101990	42" Stump Bucket, 3/8" Steel	185 lbs

Part numbers listed are not machine specific. Specify which mount is needed.

FORK GRAPPLE

The Blue Diamond® Mini Grapple Fork for mini skid steers is a versatile attachment for carrying everything from pipes and logs to pallets.

PART NUMBER	MODEL	LIFT CAP.	WEIGHT
306000	Grapple Fork, 36" Tines	3,000 LBS	405 lbs
306005	Grapple Fork, 42" Tines	3,000 LBS	423 lbs

Part numbers listed are not machine specific. Specify which mount is needed.



FEATURES INCLUDE

- 36" & 42" tines available
- Hoses and couplers included
- 1-year warranty

NURSERY



The Blue Diamond® Mini Nursery Fork is a perfect tool for moving trees and other landscaping materials around. They open to 42" wide at the inside tip of tines and can hold up to 2,000 lbs. The tines also allow them to be used as pallet forks in some applications. The curved 50" tall back rest holds trees steady during transportation. Grease fittings are on all pivot points to ensure a long life.

FEATURES INCLUDE

- 45" long tines
- Hoses and couplers included
- Can be used as pallet fork
- Mounts available to fit most mini skid steers
- 1-year warranty



PART NUMBER	MODEL	WEIGHT
114088	Nursery Fork, Hydraulic	400 lbs

Part numbers listed are not machine specific. Specify which mount is needed.

PALLET



The Blue Diamond® Mini Pallet Forks for Mini Skid Steer and Mini Track Loaders offer great visibility without sacrificing durability. The class 2 fork tines are hooked in the top and bottom of the machine carriage bar. These tines can be locked into various positions and range from 24" to 48" long. The Low Profile Mini Forks are built just like our larger frame but offer more visibility and clearance when needed.

PART NUMBER	MODEL	WEIGHT
313940	1 1/4" X 36" Tines, Pallet Fork, Low Profile	250 lbs
313950	1 1/4" X 42" Tines, Pallet Fork, Low Profile	280 lbs
313970	1 1/2" X 48" Tines, Pallet Fork, Low Profile	330 lbs
314002	1 1/4" X 36" Tines, Pallet Fork	240 lbs
314001	1 1/4" X 42" Tines, Pallet Fork	313 lbs
314000	1 1/2" X 48" Tines, Pallet Fork	313 lbs
314040	24" Tines, Pallet Fork, 1,300 Lbs Cap	180 lbs

Part numbers listed are not machine specific. Specify which mount is needed.



STANDARD



LOW-PROFILE

FEATURES INCLUDE

- Non-floating tines are hooked in top and bottom and adjust from side to side
- 2-year warranty



FORK HYDRAULIC - PALLET

The Blue Diamond® Mini Hydraulic Pallet Fork offers great load visibility and adjusts hydraulically from 8" to 40" on center.

FEATURES INCLUDE

- Offers great load visibility
- 4000 lbs capacity
- Includes hoses and couplers
- 48" tines



PART NUMBER	MODEL	LIFT CAP.	WEIGHT
114045	Pallet Fork, Hydraulic, 48" Tines	4,000 LBS	419 lbs

Part numbers listed are not machine specific. Specify which mount is needed.

GRAPPLE BUCKET



FEATURES INCLUDE

- 1" pivot pins in bushings
- Welded cylinder with 2" bore
- Protected cylinder and lines
- Available from 36" to 50" wide
- Bolt-on edge included with grapple bucket



SINGLE CLAMP

PART NUMBER	MODEL	WEIGHT
106020	36" Grapple Bucket, Single Clamp	342 lbs
106030	38" Grapple Bucket, Single Clamp	350 lbs
106032	42" Grapple Bucket, Single Clamp	358 lbs
106035	44" Grapple Bucket, Single Clamp	350 lbs
106045	50" Grapple Bucket, Single Clamp	370 lbs
106036	44" Grapple Bucket, Dual Clamp	441 lbs
106042	50" Grapple Bucket, Dual Clamp	488 lbs



DUAL CLAMP

Part numbers listed are not machine specific. Specify which mount is needed.

RAKE

The Blue Diamond® Mini Grapple Rake is a great tool for ripping up roots, pushing them into a pile, and grabbing that pile of roots. It also can be used in other applications for brush or small logs. The independently acting top clamps allow you to grab loads that are not even on both sides.



PART NUMBER	MODEL	WEIGHT
107105	42" Grapple Rake	350 lbs
107110	48" Grapple Rake	360 lbs
107120	60" Grapple Rake	450 lbs

FEATURES INCLUDE

- Curved bottom
- 42" long
- Serrated teeth on sides
- Largest in its class

Part numbers listed are not machine specific. Specify which mount is needed.

GRAPPLE ROCK BUCKET

The Blue Diamond® Mini Rock Bucket/Grapple sifts and rakes and includes dual grapples to hold your load. The leading edge can skim high spots, and the rear crossbar smooths loose soil.

PART NUMBER	MODEL	WEIGHT
108311	42" Bucket, Rock W/Grapple	425 lbs
108316	48" Bucket, Rock W/Grapple	450 lbs
108318	54" Bucket, Rock W/Grapple, Dual Top Clamps	475 lbs



54" WITH DUAL TOP CLAMPS

ROOT



Blue Diamond® offers a Mini-Series Root Grapple. These exceptionally tough grapples were designed because of the need for a tough yet light grapple for interior demolition. This very demanding application gave this grapple an opportunity to make a name for itself as the top in its class. Industrial grade components from the pivot pins to the cylinders make this attachment ready for the most demanding conditions.



PART NUMBER	MODEL	WEIGHT
106022	36" Grapple Root, Single Top Clamp	350 lbs
106025	38" Grapple Root, Single Top Clamp	360 lbs
106031	42" Grapple Root, Single Top Clamp	450 lbs
106033	44" Grapple Root, Single Top Clamp	358 lbs
106040	50" Grapple Root, Single Top Clamp	368 lbs
106043	50" Grapple Root, Double Top Clamp	500 lbs
106425	54" Grapple Root, Severe Duty	520 lbs
106435	60" Grapple Root, Severe Duty	550 lbs

FEATURES INCLUDE

- 1" pivot pins in bushings
- Welded cylinder with 2" bore
- Protected cylinder and lines
- Available from 36" to 60" wide
- Bolt-on edge included with grapple bucket

Part numbers listed are not machine specific. Specify which mount is needed.

LAND PLANE



The Blue Diamond® Land Plane, also known as a land leveler, is a very useful tool for doing fine leveling and site preparation. Cut, grade, and level with this bi-directional attachment.

PART NUMBER	MODEL	WEIGHT
115030	49" Wide, Land Plane	275 lbs

Part numbers listed are not machine specific. Specify which mount is needed.



FEATURES INCLUDE

- Bidirectional use
- Level and grade quickly
- Available for most mini machines



LOG GRAPPLE



The Blue Diamond® Mini Rotating Log Grapple is a high quality attachment for tree work. Whether you are working in the log yard or clearing land, this tool can handle the load. The serrated brace helps stabilize logs when moving. The impressive clamping force holds onto large logs very tightly. Two models are offered: manual rotation and hydraulic rotation.



FEATURES INCLUDE

- 2,000 lb capacity
- Manual or hydraulic rotation
- Opens to 66 1/2"
- Closes to under 4"
- Load stabilization brace
- Rope tie off point

PART NUMBER	MODEL	WEIGHT
106715	Log Grapple, Manual Rotation	337 lbs
106720	Log Grapple, Hydraulic Rotation	330 lbs

Part numbers listed are not machine specific. Specify which mount is needed.



LOG SPLITTER

The Blue Diamond® Mini Log Splitter can be used horizontally or vertically. The log splitter's powerful cylinder is controlled by a single, easy-to-use lever. It can handle up to a 24" log with ease. The cylinder is a 4" bore, 24" stroke with a 1 1/4" rod.



FEATURES INCLUDE

- 4" bore, 24" stroke, and 1.25" rod cylinder
- Can be used vertical or horizontal
- Splits up to 24" logs

PART NUMBER	MODEL	WEIGHT
150000	Log Splitter	475 lbs

Part numbers listed are not machine specific. Specify which mount is needed.

VIBRATORY POST DRIVER SERIES 2

The Blue Diamond® Mini Vibratory Series 2 Post Driver packs more of a punch than most hammer style drivers. By using hydraulic orbital technology, the Blue Diamond® Post Driver uses your machines' auxiliary flow in the most efficient way. Available with 4", 6", 9", 10", or 12" post adapters.

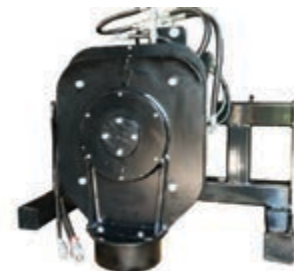

PART NUMBER	MODEL	WEIGHT
100502	Post Driver	264 lbs
100507	Post Driver w/tilt	400 lbs

Part numbers listed are not machine specific. Specify which mount is needed.



POWER RAKE STANDARD DUTY

The Blue Diamond® Standard Duty Power Rake is a lighter unit suited to smaller frame skid steers and walk behind machines. The bolt-on mount allows greater flexibility for rental companies and dealers to have the correct model for the right machine, with mounts offered for mini and full size skid steer machine.



PART NUMBER	MODEL	WEIGHT
332450	48" Power Rake With Fixed Mount	550 lbs
332451	48" Power Rake With Manual Angle Mount	600 lbs
332452	48" Power Rake With Hydraulic Angle Mount	625 lbs
332453	60" Power Rake With Fixed Mount	600 lbs
332454	60" Power Rake With Manual Angle Mount	650 lbs
332455	60" Power Rake With Hydraulic Angle Mount	675 lbs
332456	72" Power Rake With Fixed Mount	700 lbs
332457	72" Power Rake With Manual Angle Mount	750 lbs
332458	72" Power Rake With Hydraulic Angle Mount	775 lbs

Part numbers listed are not machine specific. add -25 for Mini Universal and add -26 for Bobcat MT. Weight varies on mount

FEATURES INCLUDE

- Flip up wheels
- No-flat airless wheels
- Drum width 48", 60", and 72"
- 5/8" greaseable axles on wheels
- 7" diameter drum with 1 1/2" teeth
- Overall width 12" more than drum width
- 1 1/4" spindles with adjustable height
- Bolt-on mount (can be switched for a different mini or full size skid steer mount)
- Spindles on drum are 1 3/8" diameter greaseable bearings
- Fixed carbide teeth
- Available with manual or hydraulic angle

POWER RAKE HEAVY DUTY SERIES 2

The Blue Diamond® Heavy Duty Series 2 Mini Power Rake follows close on the heels of our previously released severe duty model. This lighter unit is suited to smaller-frame skid steers and walk-behind machines. The bolt-on mount provides greater flexibility for rental companies and dealers to have the right model for the right machine, with mounts offered for mini and full size skid steer machines.



MINI-MACHINE
ATTACHMENTS



FEATURES INCLUDE

- 7" diameter drum with 1 1/2" teeth
- Chain drive unit for increased torque
- Pre-lubricated chain for easy service
- Spindles on drum are 1 3/8" diameter in greasable bearings
- 7/8" greasable axles on wheels
- Airless tires and flip up wheels
- 1 1/4" spindles with adjustable height



HYDRAULIC ANGLE KIT SHOWN ATTACHED

PART NUMBER	132407	132400	132408	132401	132409	132402	132403
SIZE/ MODEL	48"	48"	60"	60"	72"	72"	Power Rake Mount
TEETH	Replaceable	Fixed	Replaceable	Fixed	Replaceable	Fixed	-
WEIGHT	580 lbs	580 lbs	600 lbs	600 lbs	628 lbs	628 lbs	94 lbs

Part numbers listed are not machine specific. Specify which mount is needed. Weights do not include mounts. Select base model, mount and hydraulic kit.

ROTOTILLER

HEAVY DUTY

The Blue Diamond® Mini Rototiller is brutally strong for mini skid steer machines and uses all the same components as our full-size unit. The specially designed 315cc motor has built-in, oversized nose cone bearings for long life. It has swinging tines that rotate to a maximum performance angle in either direction.



FEATURES INCLUDE

- 6" tilling depth
- 12 GPM minimum flow required
- 315cc specially designed motor
- 1-year warranty

PART NUMBER	MODEL	WEIGHT
129005	48" Rototiller	382 lbs
129007	56" Rototiller	410 lbs

Part numbers listed are not machine specific. Specify which mount is needed.



SNOW BLOWER

The Blue Diamond® Mini Skid Steer Snow Blower is engineered for years of use. A high pressure bypass relief system eliminates the need for shear pins during sudden stops. With a choice of widths and motor packages, you can find the optimal sized snow blower to match your machine's capacity.



FEATURES INCLUDE

- All hydraulic fan, auger and discharge chute
- Independent fan and auger high pressure relief, no shear pins
- Direct drive auger motor, enclosed for long term protection
- Standard discharge chute with 7" opening, 52" discharge height
- 270° hydraulic rotary chute with deflector
- Single 16" auger with 4" center tube and 1 1/2" shaft
- 7-gauge auger ribbon flighting with aggressive cutting edge
- Adjustable rear skid shoes
- 18" x 6 1/2" 4-paddle fan, 7-gauge material
- 14-gauge blower shell with 12-gauge end plates
- 12-gauge fan housing with 7-gauge motor mount plate
- Powder coat finish
- Mounts available for mini universal or full size skid steer

PART NUMBER	MODEL	BEST FLOW	WEIGHT
119058	48" Snow Blower	10-13 GPM	396 lbs
119060	48" Snow Blower	14-18 GPM	396 lbs
119070	60" Snow Blower	14-18 GPM	450 lbs

Part numbers listed are not machine specific. Specify which mount is needed.

SNOW PUSHER

The Blue Diamond® Mini Snow Pusher with its rubber edge is great for clearing sidewalks and other narrow spots. The durable rubber edge cleans away the snow while not scratching the concrete or asphalt. Several sizes are available to best suit your application, and most mini skid steer mounts can be attached.



PART NUMBER	MODEL	WEIGHT
120305	42" Snow Pusher	271 lbs
120310	48" Snow Pusher	271 lbs
120320	60" Snow Pusher	320 lbs

Part numbers listed are not machine specific. Specify which mount is needed.

FEATURES INCLUDE

- Available in 42", 48", and 60" widths
- Replaceable cutting edge
- Mounts available to fit most machines



SOD ROLLER



The Blue Diamond® Sod Roller makes laying large sod rolls simple. Slide the roller shaft through the center of the roll and then pick it up with the attachment and then roll sod out. The sod roll can be mounted to the roll out driving either forward or in reverse. The short arm models fit smaller diameter rolls for machines with less capacity.

PART NUMBER	MODEL	WEIGHT
102202	36" Sod Roller with 32" Arms	205 lbs
102200	36" Sod Roller with 40" Arms	235 lbs
102206	42" Sod Roller with 32" Arms	251 lbs
102210	42" Sod Roller with 40" Arms	251 lbs
102216	50" Sod Roller with 32" Arms	268 lbs
102215	50" Sod Roller with 40" Arms	284 lbs
302310	36"- 48" Adjustable Sod Roller with 32" Arms	265 lbs
302305	36"- 48" Adjustable Sod Roller with 40" Arms	280 lbs

Part numbers listed are not machine specific. Specify which mount is needed.



ADJUSTABLE MODEL

FEATURES INCLUDE

- Fits 36", 42", and 50" rolls
- Works in forward or reverse
- Variety of mounts available
- New adjustable model available

STUMP GRINDER

The Blue Diamond® Mini Stump Grinder offers extremely high torque to take the mini capability to an entirely new level. The incredibly efficient radial piston motor, dual direction grinding and the tooth setup make stump grinding a breeze.

FEATURES INCLUDE

- High torque piston motor
- Cut moving forward or in reverse
- Greenteeth series 900 teeth
- Excellent visibility
- Case drain line required
- 16-20 GPM minimum



PART NUMBER	MODEL	MIN. FLOW	WEIGHT
104110-25	24" Cutting Wheel	16-20 GPM	795 lbs

TRAILER SPOTTER

The Mini Trailer Spotter is a great tool for moving trailers in tight areas with your mini skid steer. Accepts a 2" trailer hitch.

PART NUMBER	MODEL	WEIGHT
112012	Trailer Spotter	48 lbs

Part numbers listed are not machine specific. Specify which mount is needed.



TREE BOOM

The Blue Diamond® Tree Boom is designed for setting new trees or moving cut trees. The 1,500 lb. capacity makes this attachment useful in many applications.



PART NUMBER	MODEL	WEIGHT
112007	Tree Boom, Mini	94 lbs

Part numbers listed are not machine specific. Specify which mount is needed.

FEATURES INCLUDE

- Made from heavy structural round tube
- Total attachment height, 60"
- Extends reach 51" (beyond the quick attach)
- Hole to mount chain or strap
- 4 1/2" thick main tube

TRENCHER



The challenge with a trencher on a mini is that the limited flow range affects the performance. By using the planetary drive offered by Blue Diamond®, torque and durability are both improved substantially.



FEATURES INCLUDE

- Cuts up to 36" deep
- 4", 6" or 8" cut width
- Dirt, rock and combo teeth setups

PART NUMBER	MODEL	REQUIRED FLOW	WEIGHT
131110-25	36"Depth, 4" Dirt Chain	8-14 GPM	310 lbs
131115-25	36"Depth, 6" Dirt Chain	8-14 GPM	600 lbs
131100-25	36"Depth, 4" Combo Chain	8-14 GPM	685 lbs
131125-25	36"Depth, 4" Combo Chain	13-25 GPM	625 lbs
131104-25	36"Depth, 6" Combo Chain	8-14 GPM	700 lbs
131130-25	36"Depth, 6" Combo Chain	8-14 GPM	575 lbs
131107-25	36"Depth, 8" Combo Chain	8-14 GPM	715 lbs
131140-25	36"Depth, 4" Rock Chain	8-14 GPM	570 lbs
131145-25	36"Depth, 6" Rock Chain	8-14 GPM	580 lbs

Part numbers listed are not machine specific. Specify which mount is needed.





FORKLIFT ATTACHMENTS



INDUSTRIAL JIB

Get the extra reach you need with the Blue Diamond® Industrial Jib. Simply pull out the spring pin and go from 6' 9" to 12'. It has a lift capacity of 6,000 lbs at 6' 9" and 3,000 lbs fully extended. It slides onto forks for quick attachment. Add this jib to your inventory to get the most out of your telehandler.

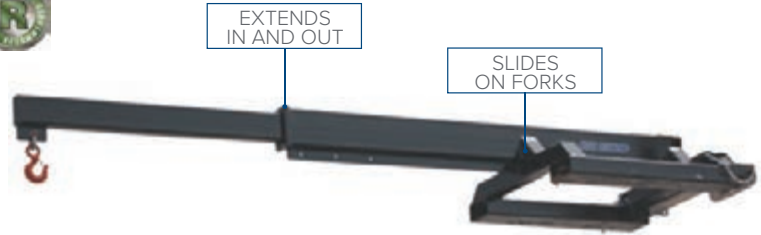

PART NUMBER	MODEL	WEIGHT
118000	Industrial Jib, Adjustable, 6,000 Cap	450 lbs
118050	Industrial Jib, 10,000 Cap, Rigid Length	345 lbs
118060	Industrial Jib, 10,000 Cap, Retracted, 4500 Lbs Cap	885 lbs

FEATURES INCLUDE

- Lift capacity of 6,000 lbs at 6' 9" and 3,000 lbs fully extended
- Slides onto forks for quick attachment



PUSH BROOM

This incredible broom will amaze you! Clean up job sites, push light snow, sweep leaves, squeegee water, or groom ball fields. Add our heavy duty magnet for picking up screws, nails, and other steel debris. The Standard Duty comes with 8 rows of bristles, and the Heavy Duty has 11 rows. Models are available in 60", 72", or 96" widths.



FEATURES INCLUDE

- Safe around people and animals
- Less dust than a rotary broom
- Does not require auxiliary power
- Moves anything from dust to small rocks
- Maintenance free
- 1-year warranty
- Also available to fit full size or mini skid steers

PART NUMBER	MODEL	WEIGHT	BRISTLES
316030	60" Standard Duty	158 lbs	8 rows
316035	72" Standard Duty	180 lbs	8 rows
316040	60" Push Heavy Duty	216 lbs	11 rows
316045	72" Push Heavy Duty	262 lbs	11 rows
316055	96" Push Heavy Duty	535 lbs	11 rows
116020	Forklift Mount (Hd Model Req 116027)	52 lbs	—

WORK PLATFORM

The Blue Diamond® Work Platform is tough, lightweight, and has many features. The mesh floor gives the driver visibility while providing stable non-slip footing. The weight capacity is 2,000 lbs, and end-fork pockets are standard on 8' and larger platforms for moving and loading in tight areas.



PART NUMBER	MODEL	WEIGHT
117010	4' X 6' Work Platform	305 lbs
117015	4' X 8' Work Platform	557 lbs
117016	4' X 8' Work Platform, w/large fork pockets	675 lbs
117020	4' X 9'8" Work Platform	875 lbs
117021	4' X 9'8" Work Platform, w/large fork pockets	675 lbs
117023	4' X 11'6" Work Platform	685 lbs
117025	4' X 12' Work Platform*	750 lbs
117026	4' X 12' Work Platform, w/large fork pockets	890 lbs

FEATURES INCLUDE

- Anchors behind fork heel
- Safety harness tie-downs
- Safety pins on doors



For a full version of Parts & Accessories, please see our Parts & Accessories Catalog or visit our website at bluediamondattachments.com.

INTERFACE CONVERSION ADAPTERS



For use with mini universal mount machine to Bobcat MT50.
Part Number: 125004



For use with skid steer to blank back; no plate, just frame tubing.
Part Number: 125055-00



For use with universal mount machine to universal skid steer.
Part Number: 125010



For use with John Deere 600/700 mount machine to universal skid steer mount.
Part Number: 125110



For use with John Deere 400/500 mount machine to universal skid steer mount.
Part Number: 125108



For use with skid steer mount machine to Bobcat MT mount.
Part Number: 125013



For use with Avant/ Multi-one mount machine to full size skid steer mount.
Part Number: 125020



For use with old style New Holland mount machine to full size skid steer mount.
Part Number: 125030

INTERFACE CONVERSION ADAPTERS



For use with blank 18x19 mini excavator machine to skid steer mount (45° angle).
Part Number: 125050



For use with Euro AG/JD Global machine to universal skid steer mount.
Part Number: 125075



For use with ASV PT30/RT40 skid steer mount machine to skid steer.
Part Number: 125022



For use with universal skid steer mount machine to mini universal mount.
Part Number: 125012



For use with Bobcat MT50 machine to mini universal skid steer mount.
Part Number: 125005



For use with ASV PT30/RT40 skid steer mount machine to mini universal mount.
Part Number: 125011



For use with Avant/Multi-one mount machine to mini universal mount.
Part Number: 125025



For use with blank 18x19 mini excavator mount machine to skid steer mount (45° angle).
Part Number: 125050



SAFETY WINDSHIELDS

1/2" THICK, MILLED EDGE INSERT



TL Series
Fits Takeuchi model:
TL250

Part Number: 203241



Cab Machines
Fits John Deere models:
318D, 319D, 320D,
323D, 326D, 328D,
329D, 332D, 333D

Part Number: 203251



M Series
Fits Bobcat models: S450,
S510, S530, S550, S570,
S590, S630, S650, S750,
S770, S850

Part Number: 203207



SSV Series
Fits Kubota models:
SSV65, SSV75

Part Number: 203263



G Cab Machines
Fits John Deere models:
314G, 317G, 318G, 320G,
324G, 325G, 330G, 332G,
333G

Part Number: 203256



JCB
Fits models: 135, 150,
175, 190, 205, 210, 215,
225, 250, 260, 270,
280, 300, 320, 3TS-8T,
3TS-8W

Part Number: 203271



SVL Series
Fits Kubota models:
SVL75, SVL90, SVL95

Part Number: 203261



CAT
Fits models: C Cab
Machines

Part Number: 203212



G Series
Fits Bobcat models: 751,
753, 763, 863, 873, 883,
S130, S150, S160, S170,
S185, S205, S220, S250,
S300, S330, T140, T180,
T190, T200, T250, T300,
T320, A220, A300

Part Number: 203205



Terex
Fits models: ASV-TR75,
VT70

Part Number: 203281

SAFETY WINDSHIELDS

1/2" THICK, MILLED EDGE INSERT



Gehl
Fits model: RT250
Part Number: 203247



Terex
Fits models: PT75, PT80
Part Number: 203283



CAT
Fits models: D Cab
Machines
Part Number: 203214



Positrack
Fits models: ASV-RC85
and RC100
Part Number: 203266



STORAGE & DISPLAY SOLUTIONS



Universal Stand
Part Number: 700006



Auger Bit Holder
Part Number: 105950



Hydraulic Breaker Holder
Holds up to 6 units (size HB50–HB300).
Part Number: 135900



Brush Cutter Display Stand
Part Number: 700005, Severe Duty models requires part 700005-SDKIT



Hydraulic Breaker Stand
Part Number: 700020



COMPLETE ATTACHMENT SOLUTIONS

4512 Anderson Road | Knoxville, TN 37918
ph 888-376-7027 | fax 865-246-2007
info@bluediamondattachments.com | BlueDiamondAttachments.com

