



PARTS & ACCESSORIES



ABOUT BLUE DIAMOND® ATTACHMENTS

Blue Diamond® Attachments is a trusted and reliable company. Established in 1995, Blue Diamond® is a widely recognized name in the global attachments industry. We are committed to unparalleled customer service from the very first call to the follow-up and service.

In today's fast-paced environment, delivering quickly and on time are key to success. Blue Diamond® Attachments stocks thousands of finished products in our warehouses every day ready to ship. This results in a big advantage for our customers with many shipments leaving in 2–3 days. Our Tennessee facilities alone are over 250,000-square-foot situated on 32 acres. These facilities, along with streamlined processes, allow most of our orders to leave our facility within 10 days. Our parts department keeps thousands of replacement parts at the ready and strives to ship all parts orders received before noon the same day the order is placed! Tracking numbers are sent to our customer the day after the shipment leaves our dock.

We are located in Knoxville, Tennessee. This central location allows our products to reach more than half of the United States population within 2–3 days' shipping time. We have many loading docks, which allow us to keep trailers from several freight companies, making use of the best freight lines available. In addition, we are the only 1-day point of export to multiple foreign ports.



WHY GENUINE BLUE DIAMOND® PARTS?

Whether you have one attachment or maintain an entire fleet, having quick access to the right parts 24/7 can make the difference in keeping your attachments working properly and staying profitable. When you buy genuine Blue Diamond® parts, you are buying top-quality parts and getting expert advice and assistance from our product support team.

Whether you get parts online or by visiting your closest Blue Diamond® dealer, buy with trust, buy with confidence, and know that we will take care of you and your attachment—the first time and every time!

Why You Can Rely on Blue Diamond® Parts:

- Blue Diamond® parts are constructed of top-quality materials, built to exact original specifications by our engineers, and rigorously tested to ensure maximum performance.
- We maintain the largest inventory of replacement parts to ensure the best possible availability, allowing you to receive your parts quickly.
- We have added hundreds of new products, including OEM replacement parts!
- Orders received Monday through Friday by 12pm EST ship the same day by 4pm!

TABLE OF CONTENTS

Blue Diamond® Parts	4-38
OEM Parts.....	40-58
Storage & Display.....	59

WHAT'S INSIDE!

Blue Diamond® sells parts for skid steers, mini skid steers, tractors, excavators, mini excavators, and forklifts, too! Throughout this catalog, you'll find a handy set of icons (shown below) for every part that indicates what machine the part is made for.



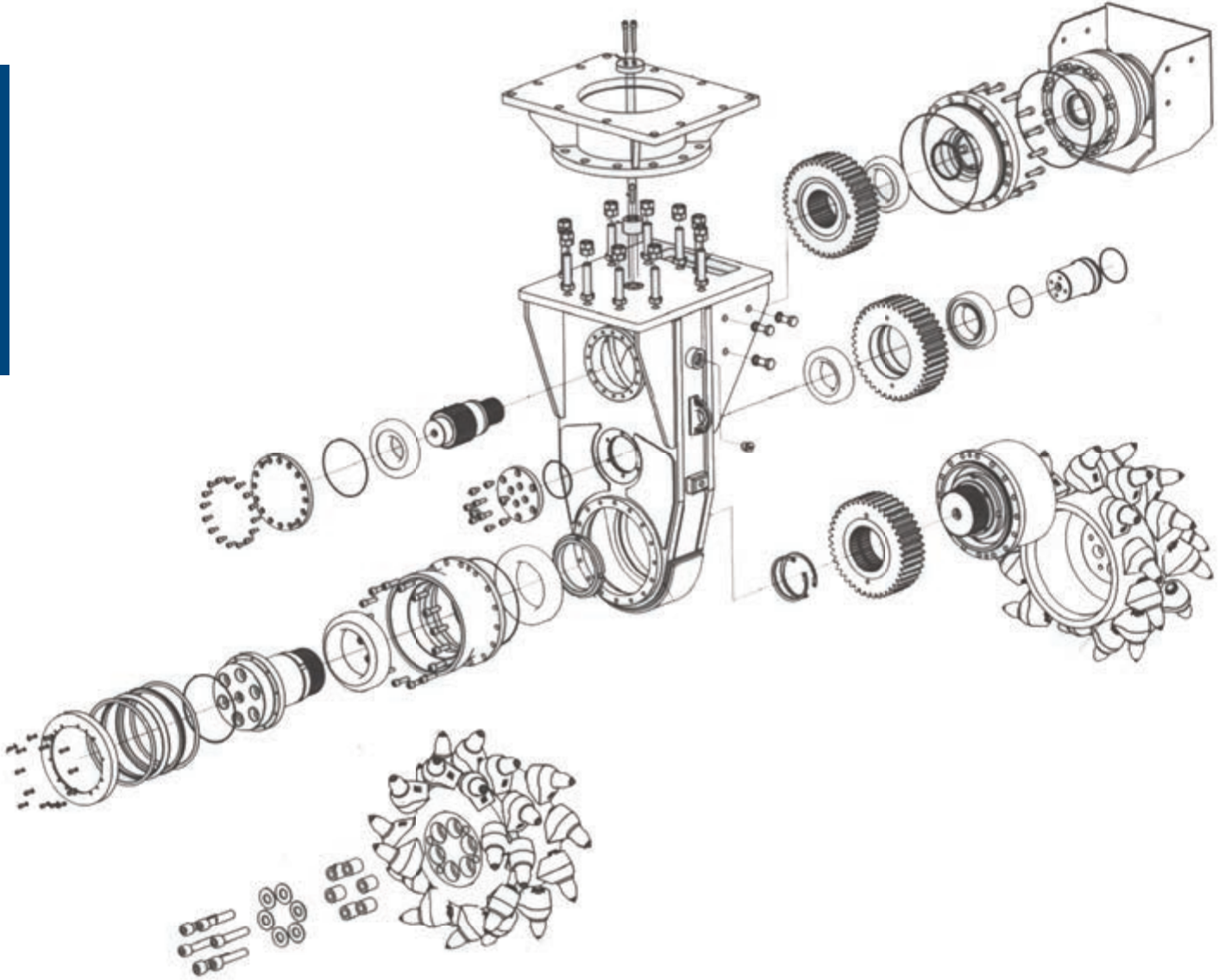

BLUE DIAMOND® PARTS

Augers	5-8	Hydraulic Breakers	26
Brooms	9-10	Pallet Fork Tines	27-28
Brush Cutters	11-14	Plows	37
Buckets	15	Power Rakes	29
Cold Planers	16	Rototillers	37
Conversion Interface Adapters	17-18	Screening Buckets	30-31
Couplers	19-20	Silt Fence Fabric	29
Decal Kits	38	Stump Grinders	29
Drum Mulchers	16	Tractor Cutters	32-34
Grapples	29	Trenchers	35-36
Hay Spears	37	Vibrating Post Drivers	37
Hoses	21-24		
Hose Protection Systems	25		

AUGERS

Auger Bits

DIAMETER	HD	HD CAST HEAD	ROCK	TREE
4"	105105	105105	105305	NA
6"	105110	105205	105310	NA
9"	105120	105210	105320	NA
12"	105130	105220	105330	NA
15"	105135	105225	105337	NA
18"	105145	105235	105345	104504
24"	105150	105239	105350	105410
30"	105155	105241	105355	105415
36"	105160	105243	105360	105420
42"	NA	105245	NA	NA
48"	NA	105250	NA	NA

Note (1): Custom sizes and lengths are available on request

Note (2): Specify collar size when ordering. We supply most bits in 2" Hex, 2" Round, 2 1/2" Hex, and 2 9/16" Round

Note (3): Part #'s listed are standard 48" length with 2" collar.



HD Bit w/Cast Head 6"
2" Hex Collar
105205



HD Bit w/ Cast Head 18" Diameter,
2" Hex Collar
105235



HD Bit 24" Diameter, 2" Hex Collar
105150



HD Auger Bit 12" Diameter, 2" Hex Collar
105130



HD Auger Bit 18" Diameter, 2" Hex Collar
105145



Auger Bit HD 4" Diameter, 2" Hex Collar
105105



Auger Bit HD 6" Diameter, 2" Hex Collar
105110



AUGERS



Wisdom Hard Face Tooth
205045



Carbide Chisel Tooth
205050



Hard Face Gauge Tooth
205040



Tooth Retaining Bolt 205025



Wisdom Tooth 205015



Gauge Tooth 205010



Carbide Bullet Tooth 205070



Carbide Wisdom Tooth 205055



Chisel Tooth 205005



AUGERS



Extensions (Variable)

	2" Hex	2" Round	2 9/16" Round
12"	-	-	205312
24"	205315	-	205317
48"	205320	205334	205335
72"	205325	-	205347

Extensions (Fixed)

	2" Hex	2" Round	2 9/16" Round
12"	205365	-	205367
24"	205370	205371	205372
48"	205375	205373	205377
72"	205380	-	205382

Extension Fixed 2" Hex 48" Long
205375



Extension Fixed 2" Hex 24" Long
205370



Carbide Fishtail Point
205065



Fishtail Point
205020



Tooth Rubber
205068



TECH TIP
Did you know?
The same tooth is used for both bolt-on and push-on units. The push-on requires that a 205068 rubber be used with it.

Adapters

Female (from)	Male (to)	
2" Hex	2 9/16" Round	205105
2" Hex	2" Round	205110
2" Hex	2 1/2" Hex	205111
2 9/16" Round	2" Hex	205115
2" Hex	2 5/8" Hex	205116
2 9/16" Round	2" Round	205120
2" Round	2" Hex	205125
2" Round	2 9/16" Round	205130
2 1/2" Hex	2" Hex	205135
2 5/8" Hex	2" Hex	205136
2 1/2" Hex	2 9/16" Round	205137

AUGERS

HD Series 2
Mini Universal Mount
205551-25



HD Series 2 Excavator
Mount with Cradle
105043



HD Series 2
Skid Steer Mount
205625



Extreme Duty Series 2
Excavator Mount with Cradle
105775



Extreme Duty Series 2
Skid Steer Mount with Knuckle
105770



Extreme Duty Series 2
Mini Extended Mount
105772-25



Adapter 2" Hex Female to 2 9/16" Round Male 205105



Adapter 2 9/16" Round Female to 2" Hex Male 205115



BROOMS



Pickup Series 37-Gallon Water Tank Assembly Kit
(includes harness and spray bar)
60": 316571 72": 316571 84": 316576 96":316579



Water Kit fits HD Series 2 and SD Angle Broom
(25 gallon)
116150



Drum Shaft Bearing
(for HD Series 2 and Pickup Series Angle Broom)
Note: NOT for Series 2 Pickup Broom
216479



Flat Nozzle for Spray Bar
216305



Threaded Nozzle for Spray Bar
216545

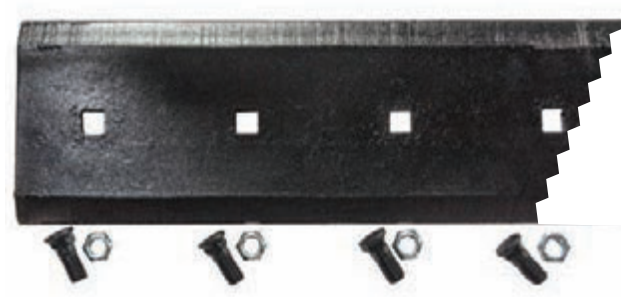

Pickup Series Bolt-on Cutting Edge 72"
216562

Additional Sizes

60"	216560
72"	216562
84"	216564
96"	216566

Pickup Series Water Tank Spray Bar
(Note: 72" spray bar shown in image)



Additional Sizes

60"	316580
72"	316583
84"	316586
96"	316589



Pickup Series Front Rubber Skirt for 60"
216453

Additional Sizes

72"	216455
84"	216457
96"	216459

Pickup Series Hydraulic Motor Support
216419



Non-Motor-Side/Standard Duty Angle Broom Bearing
(requires 2)
229010

Pickup Series Side Skirt
216451



All wear parts listed are for the original series pickup brooms.
Call our parts department for assistance with Series 2 wear parts.

BROOMS



Poly Welded Core Replacement Wafers



48"	60"	72"	84"
116042	116047	116060	116090



Poly/Steel Welded Core Replacement Wafers



48"	60"	72"	84"
116043	116045	116065	116095

Part #	Description	Qty - HD Angle Broom & Series 2 Pickup Broom
216417	26" Wafer, Poly/Steel Combo (60")	31
	26" Wafer, Poly/Steel Combo (72")	37
	26" Wafer, Poly/Steel Combo (84")	43
	26" Wafer, Poly/Steel Combo (96")	49
216415	26" Wafer, Poly (60")	16
	26" Wafer, Poly (72")	19
	26" Wafer, Poly (84")	22
	26" Wafer, Poly (96")	25
216410	26" Wafer, Steel (60")	15
	26" Wafer, Steel (72")	18
	26" Wafer, Steel (84")	21
	26" Wafer, Steel (96")	24

* 8" inside diameter

Part #	Description	Qty - Severe Duty Angle Broom
216209	32" Wafer, Poly/Steel Combo (60")	29
	32" Wafer, Poly/Steel Combo (72")	35
	32" Wafer, Poly/Steel Combo (84")	41
	32" Wafer, Poly/Steel Combo (96")	47
216207	32" Wafer, Poly (60")	15
	32" Wafer, Poly (72")	18
	32" Wafer, Poly (84")	21
	32" Wafer, Poly (96")	24
216205	32" Wafer, Steel (60")	14
	32" Wafer, Steel (72")	17
	32" Wafer, Steel (84")	20
	32" Wafer, Steel (96")	23

* 10" inside diameter



Pickup Broom Replacement Gutter Brush (11")

(poly bristle)

216605



Pickup Broom Replacement Gutter Brush (15")

(steel bristle)

216600



Pickup Broom Series 2 Gutter Brush Assembly

(steel bristle)

116555



BRUSH CUTTERS

Extreme Duty 72" Cutter Blade Kit
(4 with hardware)
203027E-KIT



TECH TIP
Why do my blades have a nick in them?
The blades knock against each other during normal use. This does not detract from their useful life.

Severe Duty 60" Excavator Cutter Blade Kit
(3 with hardware, also fits older 60" model)
203029-KIT



Heavy Duty 72" Cutter Blade Kit
(3 with hardware, also fits older 60" model)
203027H-KIT



Severe Duty 72" Cutter Blade Kit
(4 with hardware) 203025-KIT



36" 3 Blade Kit
(3 with hardware, all models) 203620-KIT



42" 3 Blade Kit
(3 with hardware, all models) 203670-KIT



50" Blade Kit
(3 with hardware, all models) 203720-KIT



60" Blade Kit
(3 with hardware, all models) 203028-KIT



Brush Cutter Bearing Grease
Shell Gadus S3 V220C2 203069

BRUSH CUTTERS

Brush Cutter Blade
(severe duty model)
203025



Standard 4 Link Discharge Chain 72"
203045



Brush Cutter Blade
(extreme duty and heavy duty models)
203027



TECH TIP
How long do the blades last?
This depends on their material, usage, and age. It varies. Check your blades frequently and change them if the cut quality is affected.



Blade Nut
(extreme & standard models) 203030



Blade Pivot Bolt
(extreme & standard models) 203035



Motor Cover/Deflector/ Inspection Cover Bolt 203006



Direct Drive Main Seal
(for 2 5/8" Spindle) 203085



Direct Drive Main Seal (large bearing style, for 3" spindle) 203086



Motor & Flange Installation Bolt 203167



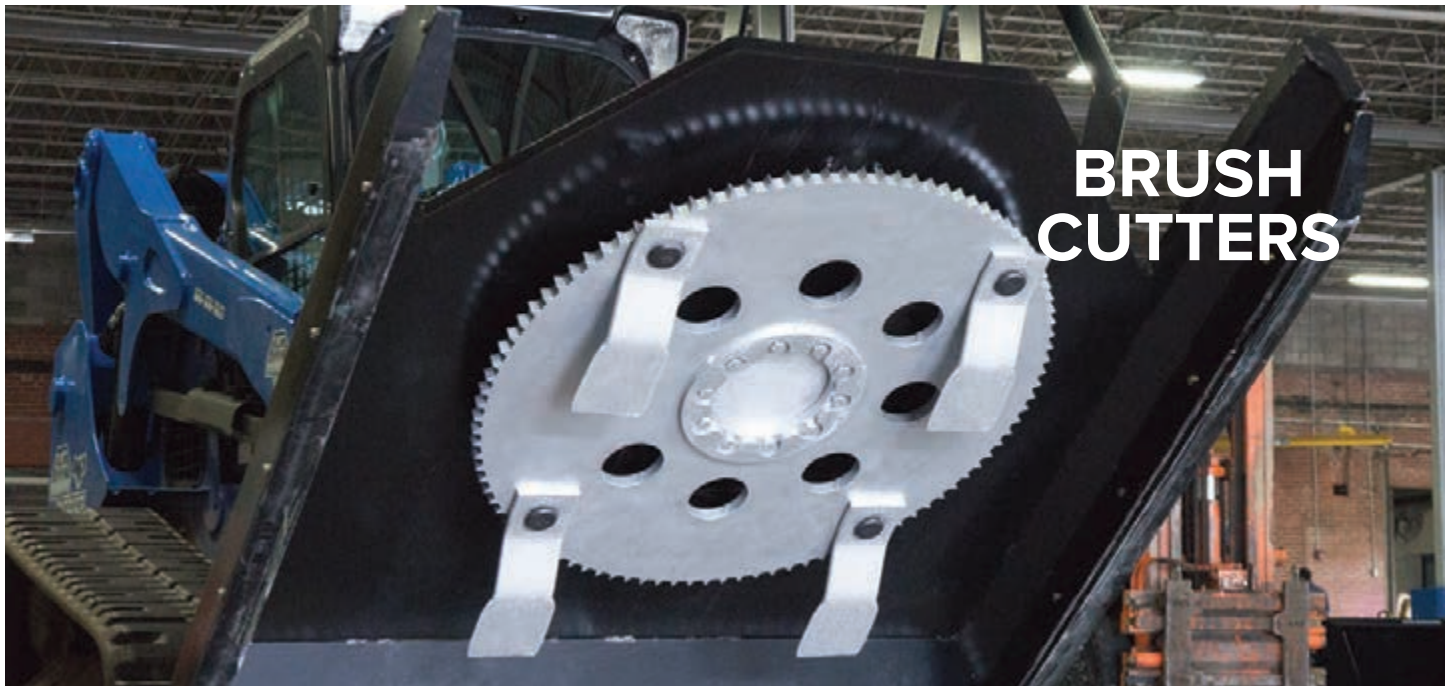

BRUSH CUTTERS

TECH TIP
What is the big noise when I'm turning off the cutter?
 This is the hydraulic braking system. The relief valves help slow the blade carrier down quickly so the operator is not endangered when exiting the machine.

Motor 160CC C-Flange with Crossport Relief Valve
 203768

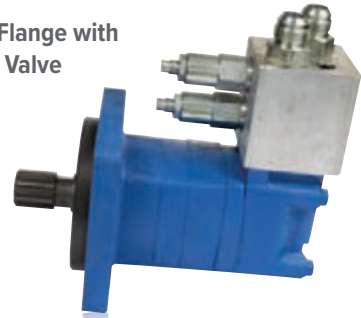

Direct Drive Bellow Assembly
 (SM straight thread for grease outlet)
 203109

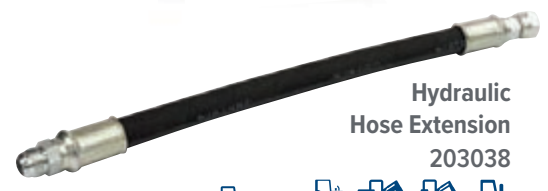

Hydraulic Hose Extension
 203038



Severe Duty Cutter Pressure Gauge
 203427



Brush Cutter Direct Drive Assembly
 (Fits 1/2" blade carrier bolts)
 203058



Brush Cutter Direct Drive Assembly
 (Fits 3/4" blade carrier bolts)
 203073





Direct Drive Bearing and Race 4.5" Diameter,
(for 2 5/8" spindle) **203075**



Direct Drive Lower Bearing and Race 5" Diameter
(for 3" spindle) **203074**



Relief Block White O-Ring **203908**



Housing Bolt and Nut 1/2" **203061**



Wire Protection Lower Bushing & Bolt **203914**



Blade Carrier Bolt for 10-Hole Spindle (long style) **203042**



BUCKETS



**Tooth Heavy Cast
(230 Side Pin)
210005**



**Rock Bucket HD Grapple
Bulk Head Branch Fitting
208580**



**Tooth and Shank Assembly
Flush Mount (230 Side Pin)
210015**



**Tooth Retainer for
230 Side Pin Tooth
210006**



TECH TIP

Maintain your teeth:
Check for loose teeth regularly. If they are loose, replace the pin.

**72" Bolt-on Edge Kit
109125**

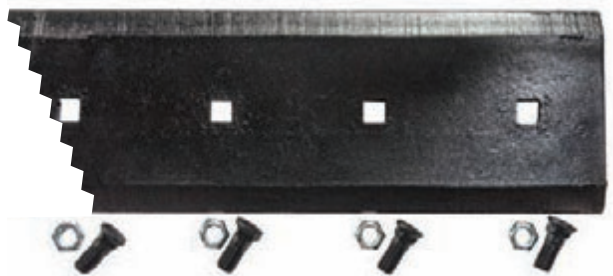

**96" Bolt-on Edge Kit
109150**

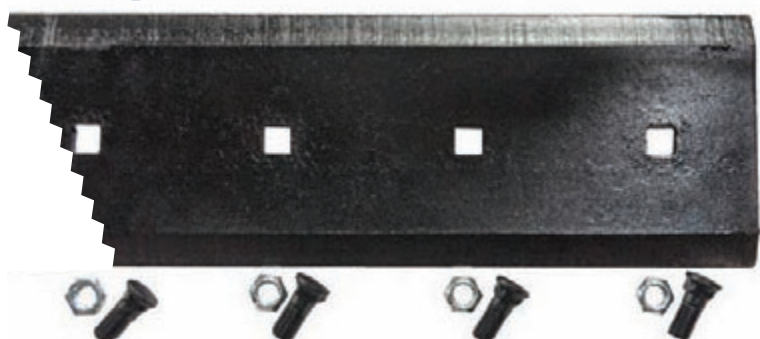

Bolt-on Edge Kits

102"	309155	56"	309113
96"	309150	54"	309112
94"	309147	52"	309111
90"	309145	50"	309110
84"	309140	48"	309109
80"	309133	47"	309103
78"	309130	45"	309108
74"	309127	44"	309107
72"	309125	42"	309106
66"	309120	38"	309105
63 1/2"	309116	36"	309104
60"	309115		



**Shop online at
www.BDAparts.com**



Cold Planer Motor End Plate Gasket
260011



Cold Planer HF Hydraulic Motor
260010



COLD PLANERS

Cold Planer Pick Removal Tooth
260070



Cold Planer Wiring Harness
160402



Cold Planer Wire Harness Assembly to use with Host Machine

HOST MACHINE	3-LINE	5-LINE
Case	160400	160405
JCB	160400	-
Volvo	160400	-
GEHL	160400	-
Bobcat	160415	160410
Cat	160425	160420
Kubota	160427	-
Deere	160435	160430



Cold Planer Control Box (Tilt/Sideshift Control Switch)
160401



Cold Planer Tooth Holder
260003



Straight Tooth
260000



Cold Planer Grooved Tooth
260001



Fine Cut Tooth
260002



Concrete Tooth
260004



Fine Cut Concrete Tooth
260005



Water Kits

12" Spray Bar	160610
16" Spray Bar	160613
18" Spray Bar	160615
24" Spray Bar	160620
30" Spray Bar	160625
40" Spray Bar	160630
48" Spray Bar	160635

DRUM MULCHERS

	Tooth Type	
Tooth Holder	Chipping (290100)	Carbide (290101)
1.5" (209200)	290100-KIT	290101-KIT
2" (290201)	290103-KIT	290104-KIT

Chipping Tooth
290100



Tooth Carbide 1-Sided
290101



Tooth Holder Weldment
1.56"
290200



Bolt for Tooth
(1"-14 x 3.5")
290107



Tooth Bolt Hex Head
(1"-14 x 3")
290105



Tooth Bolt Socket Head
(1"-14 x 3")
290108



Bolt for Tooth
(1"-14 x 2.5")
290106



Tooth Spacer for Chipping Tooth
290110



CONVERSION INTERFACE ADAPTERS



For use with mini universal mount machine to Bobcat MT50.
125004



For use with skid steer to blank back; no plate, just frame tubing.
125055-00



For use with universal mount machine to universal skid steer.
125010



For use with John Deere 600/700 mount machine to universal skid steer mount.
125110



For use with John Deere 400/500 mount machine to universal skid steer mount.
125108



For use with skid steer mount machine to Bobcat MT mount.
125013



For use with Avant/Multi-one mount machine to full size skid steer mount.
125020



For use with old style New Holland mount machine to full size skid steer mount.
125030



For use with ASV PT30/RT40 skid steer mount machine to skid steer.
125022



For use with universal skid steer mount machine to mini universal mount.
125012



CONVERSION INTERFACE ADAPTERS



For use with blank 18x19 mini excavator machine to skid steer mount (45° angle).
125050



For use with Euro AG/JD Global machine to universal skid steer mount.
125075



For use with Bobcat MT50 machine to mini universal skid steer mount.
125005



For use with ASV PT30/RT40 skid steer mount machine to mini universal mount.
125011



For use with Avant/Multi-one mount machine to mini universal mount.
125025



For use with Avant/Multi-one mount machine to full size skid steer mount
125020



Quick mount plate 1/2" that fits skid steers.
113006



Quick mount plate 1/4" that fits skid steers.
113005



COUPLERS

Attachment	Female Coupler	Male Coupler	Case Drain*
Angle Broom, HD Series 2	224020	224021	
Auger	224020	224021	
Backhoe	224005	224006	
Bale Squeeze	224005	224006	
Breaker	224012	224011	
Broom, Pickup	224020	224021	
Broom, Severe Duty	224020	224021	
Brush Cutter	224011	224012	224060, 224062
Brush Cutter 60" ED Excavator	224011	224012	FF-371-8FP
Brush Cutter, Optional High Flow**	224055	224057	224060, 224062
Bucket, 4-in-1	224007	224008	
Bucket, Dispensing	224005	224006	
Bucket, Front Dump	224005	224006	
Cold Planer	224011	224012	224060, 224062
Cold Planer, High Flow**	224055	224057	224060, 224062
Disc Mulcher	224055	224057	224060 or 224062
Dispensing Bucket	224005	224006	
Dozer Blade, Current	224011	224012	
Drum Mulcher	224055	224057	224060 or 224062
Grapple, Ext Duty or Root	224005	224006	
Grapple Fork, 4,000 lbs	224007	224008	
Grapple Fork, Severe Duty 10,000 lbs	224005	224006	
Grapple Rake HD	224005	224006	
Grapple Rake, Severe Duty	224005	224006	
Grapple, HD Bucket	224007	224008	
Grapple, HD Rake	224005	224006	
Grapple, SD Bucket or Root	224015	224016	
Hydraulic Pallet Fork	224005	224006	
Log Grapple	224005	224006	
Log Splitter, 25 ton	224005	224006	
Log Splitter, 35 ton	224009	224010	
Material Spreader	224011	224012	

Attachment	Female Coupler	Male Coupler	Case Drain*
Mat Grapple	224005	224006	
Multi-Blade	224011	224012	
Nusery Fork, Severe Duty	224005	224006	
Plate Compactor	224011	224012	
Post Driver, Hammer Style	224020	224021	
Post Driver, Vibrating	224011	224012	224060 or 224062
Power Rake	224005	224006	
Rock and Concrete Grinder	224020	224021	224060 or 224062
Rock Bucket Grapple, ED, HD, SD	224005	224006	
Roof Truss Jib	224009	224010	
Rototiller	224011	224012	
Snow Blade (Multi & Trip Edge)	224011	224012	
Snow Blower	224011	224012	
Stump Grinder	224011	224012	224060 or 224062
Stump Grinder (Optional High Flow)**	224055	224057	224060 or 224062
Rototiller	224011	224012	
Tree Puller, Standard Duty	224009	224010	
Tree Shear	224009	224010	
Trencher	224011	224012	
Trip Edge Blade	224011	224012	
Vibratory Roller	224005	224006	



* Must ask customer if the host machine has a male or female case drain fitting.

** This is a guideline only. Some machines use 5/8" couplers for high flow and others use 1/2" couplers. Confirm with customer as to what they have.

COUPLERS



Female Flat Face,
1/2" Body, 1/2" O-Ring
#8

224009



Male Flat Face,
1/2" Body, 3/4" O-Ring
#12

224012



Female Flat Face,
1/2" Body, 5/8" O-Ring
#10

224020



Male Flat Face,
1/2" O-Ring
#8

224010



Female Flat Face,
1/2" Body, 3/4" O-Ring
#12

224011



Male Flat Face,
1/2" Body, 5/8" O-Ring
#10

224021



Female Flat Face, 3/4" Body,
3/4" O-Ring #12

224055



Female Flat Face, 3/8" Body,
#8 O-Ring

224060



Vibrating Post Driver QC
Adapter, Supply & Return

200500



Male Flat Face, 3/4" Body,
3/4" O-Ring #12

224057



Male Flat Face, 3/8" Body,
#8 O-Ring

224062



Vibrating Post Driver
QC Adapter, Case Drain

200505



HOSES



**Complete Hose Kit for
84" Rock Bucket, HD Grapple**
(fits all 84" heavy duty grapple models)
208578



TECH TIP
Check hydraulic hoses for signs of deterioration. Look for indications of wear, such as cracking, blisters, and bubbles. Catching signals early helps avoid hose failure later on.



Short Hose Assembly for Brush Cutters
(All low flow models) **203039**



Short Hose Assembly for Augers **205617**



Machine Hose for SD Root Grapple **206252**



Machine Hose for SD Root Grapple
(18" longer than standard) **206253**



Machine Hose Set w/ Sleeve for Grapple (no couplers) **206360**



90" Machine Hose for Grapple
(18" longer than standard) **206361**



1/2" Auger Hoses with Couplers, 108" Long **105060**



Mini Series 1/2" Auger Hoses with Couplers, 65" Long **105061**



HOSES



**Complete Hose Kit for
78" Rock Bucket HD Grapple**
208577

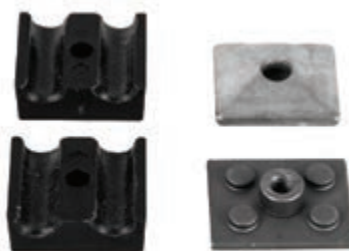

Hose Clamp
(fits 3/8" dual)
206810



**Clamp & Cylinder Hose Set for 72" Rock
Bucket HD Grapple** (fits heavy
duty rock buckets and grapples) 208565



**Hoses to Connect Rock Bucket HD
Grapple to Machine** (fits all heavy
duty rock buckets and grapples) 208585



**Hose Kit for 78" & 84" STD Rock
Bucket Grapple** (fits all heavy
duty grapples and rock buckets) 208255



Hose Set for 72" Hydraulic Angle Broom
(standard duty models only, motor to manifold) 216116



Hose Set for 72" Manual Angle Broom
(fits manual models with model numbers 1160**) 216135



**Hose Kit for 66" & 72"
Rock Bucket Standard Grapple** 208250



**Complete Hose Kit for 66" - 72"
Rock Bucket, HD Grapple** 208576



HOSES



Machine Hose for Dozer Blade Series 2
223623



Long Cylinder Hose for Mini Series Grapple
(small port end)
206097



Hose for Root Grapple
(requires 2, uses couplers 224070 & 224072)
206420



Double Clamp Short Cylinder Hose for 50" Mini Grapple
(requires 2)
206510



Double Clamp Long Cylinder Hose for 50" Mini Grapple
(requires 2)
206511



Extra Long Hose Set for Severe Duty Grapple Bucket
206363



T Fitting to Cylinder Long Hose for Severe Duty Grapple Bucket
(fits 72", 78", & 84")
206370



T Fitting to Cylinder Short Hose for Severe Duty Grapple Bucket
(fits 72", 78", & 84")
206369



Hose Kit for Skid Steer Breaker
(includes couplers)
235300



Hose Set for Tree Shear
(includes sleeves, no couplers)
228030





Hoses for Tree Puller
(couplers not included)
227010



HOSES



72" Brush Cutter Hose Set 203470
Includes couplers and H Valve
 





Brush Cutter Hose Set Assembly 203037
for High Flow Extreme Cutters
 





Brush Cutter Severe Duty 203410
Hose set with couplers
 



Brush Cutter Hose Set Assembly 203039
Low Flow with Sleeve, No couplers
 



Brush Cutter Hydraulic Hose Extension 203038
(Requires 2)
 



HOSE PROTECTION SYSTEMS



Grapple Hose Saver Kit
206800



16" Single Spring Hose Saver
206850



16" Double Spring Hose Saver
206855



25" Double Spring Hose Saver
206857



25" Single Spring Hose Saver
206852



Hose Clamp
(fits 1/4" dual hoses)
206805



Hose Clamp
(fits 1/2" dual hoses)
206815



Hose Clamp
(fits 3/4" dual hoses)
206820



Hose Clamp
(fits 1" dual hoses)
206825

HYDRAULIC BREAKERS



TECH TIP
 Limit bending the tool bit during operation. Don't use the tool bit to pry the material. Do use the correct working angle (90°) when breaking material. Don't attempt to break material using the pulling force of the machine.



Chisel

Product #	235000	235005	235010	235015	235020	235025	235030	235035	235050	235042
Fits Model	HB50	HB95	HB165	HB210	HB300	HB400	HB530	HB950	HB1400	HB1800
Weight	7 lbs	14 lbs	24 lbs	34 lbs	47 lbs	59 lbs	69 lbs	111 lbs	187 lbs	247 lbs



Moil

Product #	235001	235006	235011	235016	235021	235026	235031	235036	235051	235040
Fits Model	HB50	HB95	HB165	HB210	HB300	HB400	HB530	HB950	HB1400	HB1800
Weight	7 lbs	14 lbs	24 lbs	34 lbs	47 lbs	59 lbs	69 lbs	111 lbs	187 lbs	247 lbs



Pyramid

Product #	235002	235007	235012	235017	235022	235027	235032	235037	235054	235044
Fits Model	HB50	HB95	HB165	HB210	HB300	HB400	HB530	HB950	HB1400	HB1800
Weight	7 lbs	14 lbs	24 lbs	34 lbs	47 lbs	59 lbs	69 lbs	111 lbs	-	-



Optional Post Driving Adapters
 (includes blunt bit cables and mounting hardware)



Optional Post Driving Adapters

Fits HB210	For posts up to 5.5" diameter	235019
Fits HB300	For posts up to 5.75" diameter	235029

TECH TIP
 The post driving adapter can be added to any Blue Diamond® Hydraulic Breaker in under 10 minutes! No welding is required.



PALLET FORK TINES & PARTS

CLASS	SIZE	CAPACITY	PART #
2	1 1/4" x 4" x 36"	3,530 lbs/pair	114109
2	1 1/4" x 4" x 42"	3,530 lbs/pair	114115
2	1 1/4" x 4" x 54"	3,530 lbs/pair	114118
2	1 1/2" x 4" x 42"	5,250 lbs/pair	114113
2	1 1/2" x 4" x 48"	5,250 lbs/pair	114120
2	1 1/2" x 4" x 54"	5,500 lbs/pair	114121
2	1 1/2" x 4" x 60"	5,250 lbs/pair	114130
2	1 3/4" x 4" x 42"	6,800 lbs/pair	114123
2	1 3/4" x 4" x 48"	6,990 lbs/pair	114125
2	1 3/4" x 4" x 54"	6,800 lbs/pair	114133
2	1 3/4" x 4" x 60"	6,990 lbs/pair	114135
2	1 3/4" x 4" x 72"	6,990 lbs/pair	114145
2	1 3/4" x 4" x 96"	6,990 lbs/pair	114149
3	1 3/4" x 5" x 48"	6,990 lbs/pair	114210
3	1 3/4" x 5" x 60"	8,200 lbs/pair	114200
3	2" x 4" x 48"	8,400 lbs/pair	114203
3	2" x 5" x 60"	10,000 lbs/pair	114205
3	2" x 5" x 72"	10,000 lbs/pair	114250
3	2" x 5" x 84"	10,000 lbs/pair	114255
3	2" x 5" x 96"	10,000 lbs/pair	114260

Locking Mechanism for Flip-Style Pin Lever Tines
 (1 per tine)
214012



Hydraulic Adjusting Fork Cylinder
214105





PALLET FORK TINES & PARTS

TECH TIP

How many forks per pallet order?

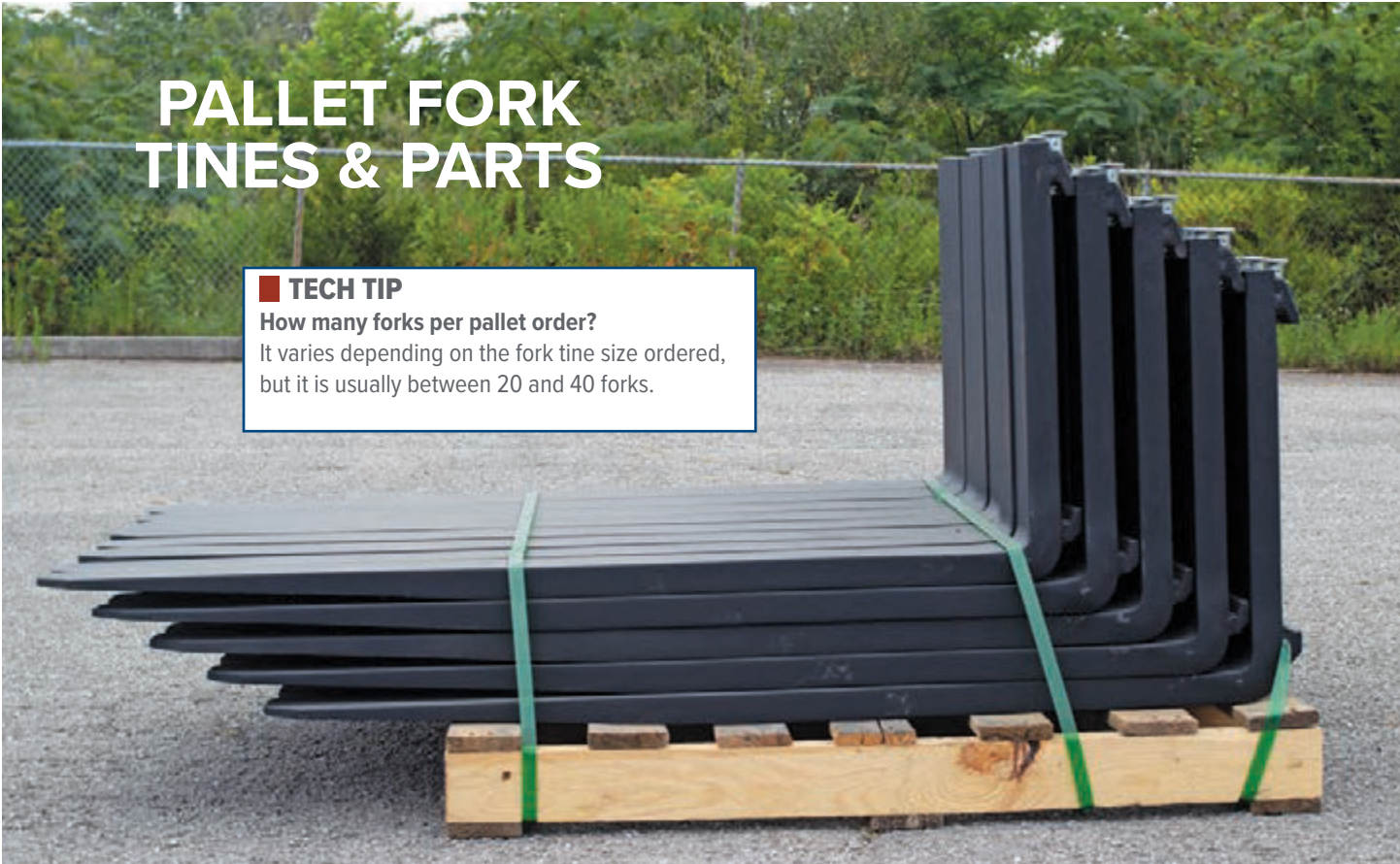
It varies depending on the fork tine size ordered, but it is usually between 20 and 40 forks.



1 1/2" x 4" x 48" Tine

114120



1 1/2" x 4" x 60" Tine

114130



1 3/4" x 4" x 60" Tine

114135



1 3/4" x 4" x 72" Tine

114145



STUMP GRINDERS

TECH TIP

How long do teeth last?

Teeth can be turned a few times, so they last a good amount of time. The exact time depends on the material and time used. Check them regularly, turn them as needed, and always replace chipped or dull teeth.



Greenteeth® for Piston Style Stump Grinder 204505



Greenteeth® Pocket, Angle 204510



Greenteeth® Pocket, Reverse 204512



Greenteeth® Pocket, Straight 204514



Stump Grinder Bolt for Tooth Pocket 204508



Hydraulic Angle Kit

POWER RAKES

	Severe Duty	Heavy Duty Series 2 - Mini 58" Hoses	Heavy Duty Series 2 - Full Size 58" Hoses	Extreme Duty/ Severe Duty Series 3
48" & 60"	-	332460-58	332460-85	-
72"	332061	332462-58	332462-85	332520
84"	332061	-	-	332520
96"	332062	-	-	332525
120"	332063	-	-	332530

Note: Hydraulic Angle Kits are also available for 3 point hitch models, please contact us for further information

Note: Kit shown #332520



Machine Side Hose Set (fits 72"-84", no couplers) 232066

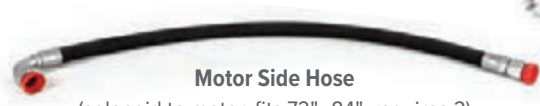

Motor Side Hose (solenoid to motor, fits 72"-84", requires 2) 232065



Replaceable Tooth Tapered No jam nut required 232117



GRAPPLES



Cylinder 2" Bore, 10" Stroke (1/4" ports, fits SD Grapple Bucket) 206306



Cylinder Seal Kit (for AG-style maxim) 206111



SILT FENCE



Fabric (by the foot) 275108



Fabric (bulk roll, 1,500 feet) 275110



SCREENING BUCKETS



Hydraulic Motor AGMP 125
(with SAE Spline Shaft 4-40HE & 4-47HE)

245215



Hydraulic Motor AGMP 125
(with SAE Spline Shaft 3-33E)

245200



Hydraulic Motor AGMP 150
(with SAE Spline Shaft 3-47S)

245205



Hydraulic Motor AGMP 200
(with SAE Spline Shaft 3-60S)

245210



Carbon Belt Pulley
8MDC3645

245050



Carbon Belt Pulley
IMDC21TB46

245055



Locking Ring 20 mm

245030



Carbon Belt 8MDC-24

245070



Gates Carbon Belt 8MDC-36

245065



Carbon Belt 8MDC-40

245060



SCREENING BUCKETS



Bearing SLFE7/8C106
245130



Bearing SLFE25C104
245120



Bearing SLFT30C100
245125



Taper Bushing 2012-25 245100



Taper Bushing 2012-30 245105



Rosta Belt Roller 245150

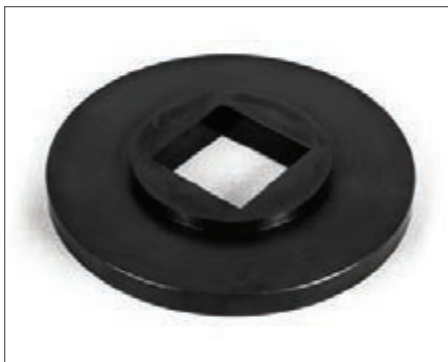

End Cap 15 mm 245025

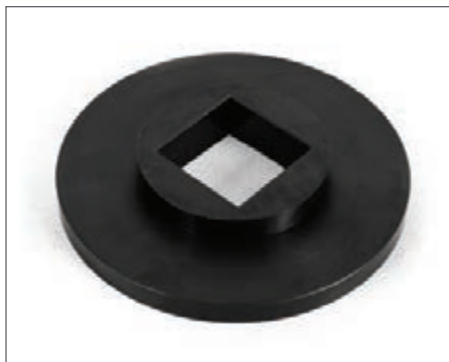

End Cap 20 mm 245020



Poly Star Blue 245000



3.5' Tractor Cutter Blade
503248



TRACTOR CUTTERS

Blades are sold in pairs.

4' Tractor Cutter Blade
503251



Tractor Cutter Blade
503250



5' Tractor Cutter Blade
503254



8' Reverse Cutter Tractor Blade
503252



10' Reverse Cutter Tractor Blade
503256



Tractor Cutter Left-Hand Wing Blade
503155



Tractor Cutter Right-Hand Wing Blade
503260



6' Tractor Cutter Blade
503258



7' Heavy Duty Tractor Cutter Blade
503262



6' Heavy Duty Tractor Cutter Blade
503261



TRACTOR CUTTERS



**Blade Carrier Retainer
Castle Nut & Cotter Pin**
503226



Complete Driveline
100 hp with slip clutch gearbox, 403120
503915



Blade Carrier Retaining Kit
503203



6' Tractor Cutter Blade Carrier
(fits 1300, 1400, 1500, 1600,
1810, 1810P Series)
503210



Bolt Kit 4-Pack
5/8" x 2"
503201



Tractor Cutter Blade Carrier
(fits 1708-1808 Series)
503220



Gearbox Sheild 503000



Bolt Kit 503202



Blade Carrier Center 503230





Shearpin Driveline
830 mm Series 4
503005



75 HP Shearpin Gearbox
503020



Shearpin Driveline
960 mm Series 4
503010



Shearpin Driveline
1200 mm Series 4
503015



4' Mower Blade
60" x 6"

503242



5' Mower Blade
60" x 6"

503244



7' Mower Blade
60" x 6"

503240



TRACTOR CUTTERS



Flail Mower Y-Blades

(fits 403710)

503282



Flail Mower Y-Blades

(fits 403720)

503283



Flail Mower
Hammer Blades

(fits FMH-175H)

503287



Flail Mower
Hammer Blades

(fits FMH-205H)

503288



TRENCHERS



TECH TIP
Did you know?
 To avoid overlooking worn or damaged components during inspection, clean the trencher with a power washer to eliminate all dirt, oil, and grease. Keep all safety decals clean and legible.



Left Cup Tooth
 (48" trencher)
 231018



Center Rock Tooth
 (48" trencher)
 231015



Right Cup Tooth
 (48" trencher)
 231019



Trencher Nose Roller includes Bearing and Circlip
 (fits 48" and 60" models)
 231094



Trencher Nose Roller includes Bearing and Circlip
 (fits 36" models)
 231092



Center Rock Tooth
 (48" trencher, requires 8)
 231005





Right Rock Tooth
(48" trencher)
231017



Left Rock Tooth
(48" trencher)
231016



TRENCHERS

Trencher Teeth

Right Rock Tooth (48" trencher)	231017
Left Rock Tooth (48" trencher)	231016
Right Cup Tooth (48" trencher)	231019
Left Cup Tooth (48" trencher)	231018
Center Rock Tooth (48" trencher)	231015
Right Cup Tooth (36" trencher, requires 6)	231009
Left Cup Tooth (36" trencher, requires 6)	231008
Right Rock Tooth (36" trencher, requires 6)	231007
Left Rock Tooth (36" trencher, requires 6)	231006
Center Rock Tooth (36" trencher, requires 8)	231005



Left Cup Tooth
(36" trencher, requires 6)
231008



Right Cup Tooth
(36" trencher, requires 6)
231009



Right Rock Tooth
(36" trencher, requires 6)
231007



Left Rock Tooth
(36" trencher, requires 6)
231006



Trencher Hose Set
(fits mini & full-size skid steer models)
231000



Trencher Chains

	Earth	Rock	Combo
36" x 4"	231500	231530	231515
36" x 6"	231019	231535	231520
36" x 8"	231018	231540	231525
48" x 6"	231015	231590	231570
48" x 8"	231009	231595	231575
48" x 10"	231008	-	231580
48" x 12"	231007	-	231585

Note: Additional trencher chains and custom trencher chain sizes may be available upon request



Trencher Complete Replacement Chain
(3', 4")
231500

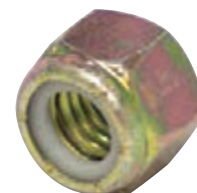

Chain Locknut 1/2"
231070



ROTOTILLERS

Rototiller Motor
(400 cc)
229006



**Non-Motor-Side
Rototiller Bearing**
229010



Left-Hand Curved Blade
(standard, for VH90
rototiller)
529200



Right-Hand Curved Blade
(standard, for VH90
rototiller)
529201



Rototiller Tine & Bolt
229016



VIBRATING POST DRIVERS



**Vibrating Post Driver
Rubber Bushing**
200575



4\"/>



6\"/>

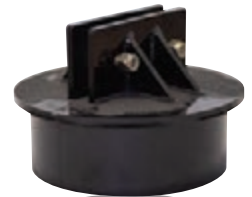

9\"/>



**Vibrating Post Driver Tilt
Solenoid Complete Assembly**
200510



10\"/>



12\"/>



PLOWS

Plow Bar Plate Shearbolt Kit
(7/16" x 2 1/2", 5 pack)
540000



HAY SPEARS



**Standard Duty
Removable Stabilizer**
211007



**Heavy Duty
Removable Stabilizer**
211009

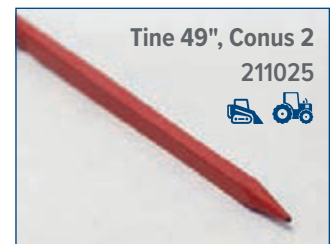

Tine 49\", Conus 2
211025



DECAL KITS



Decal Kits

72" Extreme Duty Open Front Cutter	BDKIT-03001
72" Extreme Duty Closed Front Cutter	BDKIT-03002
42" Severe Duty Mini Ex Cutter	BDKIT-03003
Root Grapple, Extreme Duty (specify size)	BDKIT-06005
36" Mini Ex Heavy Duty Brush Cutter	BDKIT-03008
42" Ex Heavy Duty Brush Cutter	BDKIT-03009
50" Ex Heavy Duty Brush Cutter	BDKIT-03010
60" Heavy Duty Skid Steer Brush Cutter	BDKIT-03006
60" Heavy Duty Open Front Brush Cutter	BDKIT-03007
72" Heavy Duty Skid Steer Brush Cutter	BDKIT-03004
72" Severe Duty Brush Cutter	BDKIT-03005
Stump Grinder Standard Flow	BDKIT-04001
Stump Grinder High Flow	BDKIT-04002
Swing Arm Stump Grinder	BDKIT-04003
Cold Planer High Flow (specify size)	BDKIT-60001
Cold Planer Standard Flow (specify size)	BDKIT-60002
Pickup Broom (specify size)	BDKIT-16001

Auger 6H	BDKIT-05001
Auger 10H	BDKIT-05002
Auger 15H	BDKIT-05003
Auger 1000ED	BDKIT-05004
Auger 1500ED	BDKIT-05005
Auger 2000ED	BDKIT-05006
Auger 2500ED	BDKIT-05007
Auger 3000ED	BDKIT-05008
Post Driver Hydraulic Pounding Style	BDKIT-00001
Post Driver Vibrating Style	BDKIT-00002
Power Rake Extreme (specify size)	BDKIT-32001
Power Rake Severe (specify size)	BDKIT-32002
Rototiller (specify size)	BDKIT-29001
Snow Blower (specify size)	BDKIT-19001
Tree Shear	BDKIT-28001
Trencher (specify model)	BDKIT-31001



Genuine Blue Diamond® parts at your fingertips

24/7/365

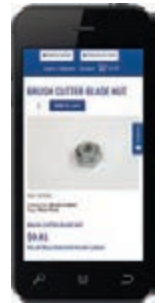
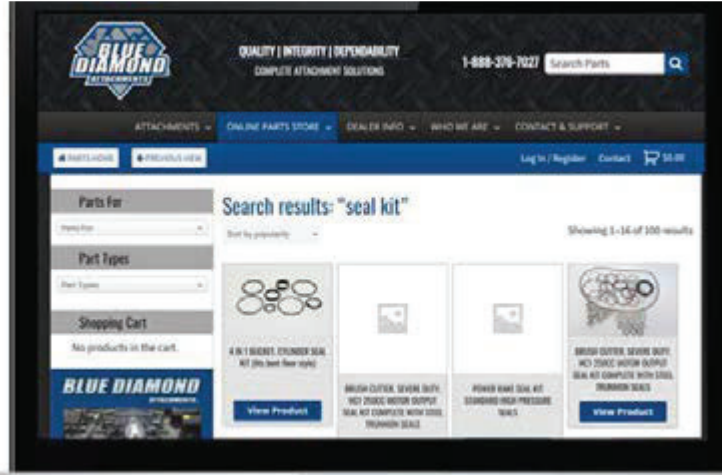

DON'T WAIT, SAVE TIME,
BUY BLUE DIAMOND® PARTS ONLINE!
BDAparts.com





OEM REPLACEMENT PARTS

To better serve our dealers, Blue Diamond® Attachments is now stocking OEM replacement parts for the brands you sell and service.

Bobcat	41-45	Takeuchi	53
Case.....	46-47	Universal Mirrors	54
John Deere	48-49	Storage & Display	59
Kubota	50		
New Holland	51-52		
Safety Windshields	56-58		
Sprockets.....	55		

BOBCAT



Windshield Wiper Blade Holder
(fits Bobcat M Series skid steers)
601040



Key (set of 2)
(fits Bobcat, Case, Genie
Telehandler, Ingersoll-Rand
Compactor, Timberjack Skidder)
601000



Key (set of 2)
(fits Bobcat Old Style)
601006



Windshield Wiper Blade 22"
Bobcat Skid Steers: A220, A300, S100, S130,
S150, S160, S205, S220, S250, S300, S330,
T110, T140, T180, T190, T200, T250, T300,
T320, 751, 753, 763, 773, 863, 864, 873,
963, 870
601016



Windshield Wiper Blade 28"
Bobcat Skid Steers: S510, S530, S550, S570,
S590, S630, S650, S750, S770, S850, T550,
T590, T630, T650, T750, T770, T870
601030



Windshield Wiper Blade Arm
Bobcat Skid Steers: A220, A300, S100, S130,
S150, S160, S205, S220, S250, S300, S330,
T110, T140, T180, T190, T200, T250, T300,
T320, 751, 753, 763, 773, 863, 864, 873,
963
601042



Quick Coupler Complete Plate
Bobcat Skid Steers: S510, S530, S550, S570,
S590, S595
(includes lever kits and 2 bushings)
601088



Quick Coupler Complete Plate
Bobcat Skid Steers: S150, S160, S175, S185,
S205, T180, T190, 773
(includes lever kits and 2 bushings)
601090



Quick Coupler Complete Plate
Bobcat Skid Steers: AA300, S220, S250,
S300, T250, T300, T320
(includes lever kits and 2 bushings)
601092



Quick Coupler Complete Plate
Bobcat Skid Steers: A770, S630, S650, S740,
S750, S770, T630, T650, T740, T750, T770, T870
(includes lever kits and 2 bushings)
601094



Tail Light Replacement Lens
Bobcat Skid Steers: A220, A300, S100, S130, S150, S160,
S175, S185, S205, S220, S250, S300, S330, S510, S530,
S550, S570, S590, S630, S650, S750, S770, T110, T140,
T180, T190, T200, T250, T300, T320, T550, T590, T630,
T650, T750, T770, T870, 751, 753, 763, 773, 863, 864,
873, 883, 963
601024





Quick Attach Main Pivot Bushing

Bobcat Skid Steers: S100, S130, S150, S160, S175, S185, S205, S220, S250, S300, S330, S630, S650, S750, S770, T110, T140, T180, T190, T200, T250, T300, T320, T630, T650, T750, T770, A220, 653, 751, 753, 763, 773, 863, 864, 873, 883

(requires 2)

601002



Quick Attach Main Pivot Bushing

Bobcat Skid Steers: S100, S130, S150, S160, S175, S185, S205, S220, S250, S300, S330, T110, T140, T180, T190, T200, T250, T300, T320, A250, A300 743, 751, 753, 763, 773, 863, 873, 883, 963

(requires 2)

601008



BOBCAT

Shop online at
www.BDAparts.com



Quick Attach Main Pivot Bushing

Bobcat Skid Steers: S100, S130, S150, S160, S175, S185, S205, S220, S250, S300, S330, S510, S530, S550, S630, S650, S750, S770, T110, T140, T180, T190, T200, T250, T300, T320, A250, A300

(requires 2)

601010



Quick Attach Main Torsion Bushing

Bobcat Skid Steers: A250, A300, S100, S130, S150, S160, S175, S185, S205, S220, S250, S300, S510, S530, S550, S570, S590, S630, S650, S750, S770, T110, T140, T180, T190, T200, T250, T300, T320, T550, T590, T630, T650, T750, T770, T870, 751, 753, 763, 773, 863, 873, 883, 963

(requires 2)

601012



Quick Attach Main Pivot Bushing

Bobcat Skid Steers: A300, S150, S160, S175, S185, S205, S220, S250, S300, T180, T190, T200, T250, T300, T320, 773

(requires 2)

601018



Quick Attach Main Pivot Bushing

Bobcat Skid Steers: A220, A300, S100, S130, S150, S160, S175, S185, S205, S220, S250, S300, S330, S510, S530, S550, S570, S590, S630, S650, S750, S770, T110, T140, T180, T190, T200, T250, T300, T320, T550, T590, T630, T650, T750, T770, T870, 751, 753, 763, 773, 863, 864, 873, 883, 963

(requires 2)

601026



Quick Attach Main Pivot Bushing

Bobcat Skid Steers: A300, (Large Frame) S220, S250, S300, S330, T250, T300, T320

(requires 2)

601048



Quick Attach Main Pivot Bushing

Bobcat Skid Steers: A770, S630, S650, S740, S750, S770, T630, T650, T740, T750, T770, T870

(requires 2)

601062



BOBCAT



LEVER & WEDGE KITS
Right Side Bobcat M Series
 (includes lever spring pin and hardware)
601072



Left Side Bobcat M Series
 (includes lever spring pin and hardware)
601078



Right Side Bobcat G Series
 (includes lever spring pin and hardware)
601074



Left Side Bobcat G Series
 (includes lever spring pin and hardware)
601076



Quick Attached Pivot Kit for Lever
 Bobcat Skid Steers (new style): S510, S530, S550, S570, S590, S630, S650, S750, S770, T550, T590, T630, T650, T750, T770, T870
 (includes 1 pivot wedge pin, 1 roll pin, 1 socket head bolt)
601044



Quick Attached Pivot Kit for Lever
 Bobcat Skid Steers (old style): S510, S530, S550, S570, S590, S630, S650, S750, S770, T550, T590, T630, T650, T750, T770, T870
601046



Quick Attach Lever for Left Side

Bobcat Skid Steers: A220, A300, A770, S100, S130, S150, S160, S175, S185, S205, S220, S250, S300, S330, S510, S530, S550, S570, S590, S630, S650, S750, S770, S850, T110, T130, T140, T180, T190, T200, T250, T300, T320, T450, T550, T590, T630, T650, T750, T770, T870, 553, 630*, 631*, 632, 632*, 641*, 642*, 643*, 645*, 653, 730*, 732*, 741*, 742*, 743*, 751, 753, 763, 773, 853, 863, 864, 873, 883, 963
 (* these models have more than one Bobtach option)
601050



Quick Attach Lever for Right Side

Bobcat Skid Steers: A220, A300, A770, S100, S130, S150, S160, S175, S185, S205, S220, S250, S300, S330, S510, S530, S550, S570, S590, S630, S650, S750, S770, S850, T110, T130, T140, T180, T190, T200, T250, T300, T320, T450, T550, T590, T630, T650, T750, T770, T870, 553, 630*, 631*, 632, 632*, 641*, 642*, 643*, 645*, 653, 730*, 732*, 741*, 742*, 743*, 751, 753, 763, 773, 853, 863, 864, 873, 883, 963
 (* these models have more than one Bobtach option)
601052



Fuel Cap
 (fits Bobcat skid steers)
601014



Drive Belt Arm Tensioner (arm only)
 Bobcat Skid Steers: 751, 753, 763, 773, 7753, 853, 863, 873, 883, 953, 963, S100, S130, S150, S160, S175, S185, S205, S220, S250, S300, S330, T110, T140, T180, T190, T200, T250, T300, T320, A250, A300
601060



Drive Belt Arm Tensioner
 Bobcat Skid Steers: S100, S130, S150, S160, S175, S185, S205, T140, 751, 753, 763, 773, 863, 883, 963
601082



Shop online at
www.BDAparts.com



Main Pivot Kit for Lever

Skid Steer Loaders: A220, A300, S100, S130, S150, S160, S175, S185, S205, S220, S250, S300, S330, T110, T130, T140, T180, T190, T200, T250, T300, T320, 553, 630, 631, 632, 641, 642, 643, 645, 653, 730, 732, 741, 742, 743, 753, 763, 773, 853, 863, 864, 873, 883, 963
601022

Main Pivot Kit for Lever

Skid Steer Loaders: A770, S510, S530, S550, S570, S590, S630, S650, S750, S770, S850, T450, T550, T590, T630, T650, T750, T770, T870
601020



OEM PARTS



Door Spring

Bobcat Skid Steers: 530, 540, 543, 553, 630, 631, 642, 643, 645, 731, 732, 741, 742, 743, 751, 773 (SNs 509616001–50962999 509635001 and above), 825, 843, 853, 943, 953
(shock measures 18 1/4" center to center from the ball stud to mounting hole)
601036

Door Spring

Bobcat Skid Steers: A220, A300, S100, S130, S150, S160, S175, S185, S205, S220, S250, S300, S330, T110, T140, T190, T200, T250, T300, T320, 751, 753, 763, 773, 863, 864, 873, 883, 963
601032

Door Spring

Bobcat Skid Steers: S510, S530, S550, S570, S590, S630, S650, S750, S770, T550, T590, T630, T650, T750, T770, T870
601054



Pivot Pin for

Quick Attach & Boom

Bobcat Skid Steers: 520, 530, 533, 540, 542, 542B, 543, 630, 631, 632, 641, 642, 643, 645, 730, 731, 732, 741, 742, 743, 753, 7753
601034



Quick Attach Lower Pivot Pin

Bobcat Skid Steers: T110, T140, T180, T190
601038



Quick Attach Lower Pivot Pin

Bobcat Skid Steers: A770, S630, S650, S740, S750, S770, T630, T650, T740, T750, T770, T870
601066



Quick Attach Pivot Pin Kit (small)

Bobcat Skid Steers: S220, S250, S300, S330, T250, T300, T320
601056



Quick Attach Lower Pivot Pin

Bobcat Skid Steers: 751, 753, 763, 773, 7753, 853, 863, 873, 883, 953, 963, S100, S130, S150, S160, S175, S185, S205, S220, S250, S300, S330, T110, T140, T180, T190, T200, T250, T300, T320, A250, A300
601058



Quick Attach Wedge Pin

Bobcat Skid Steers: A220, A300, A770, S100, S130, S150, S160, S175, S185, S205, S220, S250, S300, S330, S510, S530, S550, S570, S590, S630, S650, S750, S770, S850, T110, T130, T140, T180, T190, T200, T250, T300, T320, T450, T550, T590, T630, T650, T750, T770, T870, 553, 630, 631, 632, 641, 642, 643, 645, 653, 730, 732, 741, 742, 743, 751, 753, 763, 773, 853, 863, 864, 873, 883, 963
601068



BOBCAT

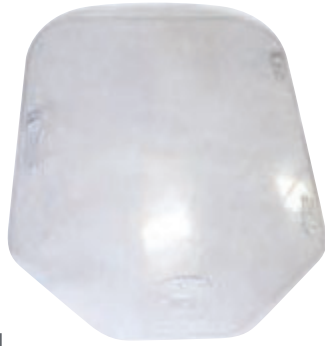

M Series Safety Windshield

Fits models: S450, S510, S530, S550, S570, S590, S630, S650, S750, S770, S850
(1/2" thick, milled edge insert)

203207



G Series Safety Windshield

Fits models: 751, 753, 763, 863, 873, 883, S130, S150, S160, S170, S185, S205, S220, S250, S300, S330, T140, T180, T190, T200, T250, T300, T320, A220, A300
(1/2" thick, milled edge insert)

203205



Quick Attach Hydraulic Cylinder

Bobcat Skid Steers: 753, 763, 773, 863, 864, 873, 883, A220, A300, S100, S130, S150, S160, S175, S185, S205, S220, S250, S300, S330, T110, T140, T180, T190, T200, T250, T300, T320

601086



Quick Attach Hydraulic Cylinder

Bobcat Skid Steers: A770, S510, S530, S550, S570, S590, S595, S630, S650, S750, S770, S850, T450, T550, T590, T595, T630, T650

601084



Cab Lock Down Mechanism

Bobcat Skid Steers: 440, 443, 450, 453, 463, 520, 530, 533, 540, 542, 543, 553, 630, 631, 632, 641, 642, 643, 645, 653, 730, 731, 732, 741, 742, 743, 751, 753, 763, 773, 843, 853, 863, 864, 873, 883, 953, 963, 7753, A220, A300, MT50, MT52, MT55, S70, S100, S130, S150, S160, S175, S185, S205, S220, S250, S300, S330, S630, S650, S850, T110, T140, T180, T190, T200, T250, T300, T320, T630, T650, T870, 320, 322, 325, 328, 331, 334, 337, 341, 442

601064



Stud & Nut Replacement Set

Skid Steer Loaders: A220, A300, A770, S70, S100, S130, S150, S160, S175, S185, S205, S220, S250, S300, S330, S510, S530, S550, S570, S590, S630, S650, S750, S770, S850, T110, T130, T140, T180, T190, T200, T250, T300, T320, T450, T550, T590, T630, T650, T750, T770, T870, 500, 520, 530, 533, 540, 542B, 543, 553, 600, 610, 611, 620, 630, 631, 632, 641, 642, 643, 645, 653, 700, 720, 730, 731, 732, 741, 742, 743, 751, 753, 763, 773, 843, 853, 863, 864, 873, 883, 963
(requires 1 per wheel)

601028



Safety Mirror Kit

Fits Bobcat Skid Steers
M & G Series
(includes hardware)

601080



Drive Belt Arm Tensioner Complete Assembly

Bobcat Skid Steers: 751, 753, 763, 773, 753, 853, 863, 873, 883, 953, 963, S100, S130, S150, S160, S175, S185, S205, S220, S250, S300, S330, T110, T140, T180, T190, T200, T250, T300, T320, A250, A300

601070



CASE



Quick Coupler Complete Plate
 Case Skid Steers: 1835, 1835B, 1835C, 1838, 1840
 (includes lever kit and 2 bushings)
601118



Quick Coupler Complete Plate
 Case Skid Steers: 1845, 1845B, 1845C
 (includes lever kit and 2 bushings)
601114



Quick Coupler Complete Plate
 Case Skid Steers: 75XT, 85XT, 90XT, 95XT, 445, 445CT, 450, 450CT, 465
 (includes lever kit and 2 bushings)
601120



Quick Coupler Complete Plate
 Case/New Holland Skid Steers: SR174, SR200, SR220, S250, SV185, SV250, SV300, TR270, TR320, TV380, L218, L220, L223, L225, L230, C227, C232
 (includes lever kit and 2 bushings)
601138



Quick Coupler Complete Plate
 Case Skid Steers: 40XT, 60XT, 70XT, 410, 420, 420CT, 430, 440, 440CT
 (includes lever kit and 2 bushings)
601116



Key (set of 2)
 (fits Case machines)
601100



Door Spring
 Case Skid Steers: 1835C, 1838, 1840, 1845C
601102



Quick Attached Lever & Wedge Kit
 Case Skid Steer Loaders: 1835C, 1838, 1840, 1845C Series
 (requires 2, includes lever spring pin and hardware)
601108



Quick Attach Main Pivot Single Bushing
 Case/New Holland Skid Steers: SR130, SR150, SR175, SR200, SR220, SR250, SV185, SV250, V300, SV340, TR270, TR310, TR320, TV380LS160, LS170, L213, L215, L218, L220, L221, L223, L225, L230, L234

(requires 2)
 Single **601122**





Sprocket

8 Bolt x 17 Teeth

Commonly fits models: CT420, CT440, CT445, CT450, TV 380, TR270, TR310, TR320, TR340, C175, C185, C190, LT185, LT190, C227, C232, C238 (please verify serial number)

603345



450 Width Rubber Tracks

450 x 86 x 55

Fits models: 445CT, TR320, TR340, TV370, TV380

603145



Quick Attach Lever Only

Case/New Holland Skid Steers

Left Side **601126**

Right Side **601128**



Quick Attach Lever & Wedge Kit

Case Skid Steers: 75XT, 85XT, 90XT, 95XT, 445, 445CT, 450, 450CT, 465 (includes lever spring pin and hardware)

Left Side Kit **601109**

Right Side Kit **601110**



Quick Attach Main Pivot Pin Kit

Case/New Holland Skid Steers: L216–L230, C232–C238, SR160–SR250, SV185–SV300, TV380, TR270–TR340

601132



Windshield Wiper Blade Arm

(fits Case 200 Series Skid Steers)

601104



Windshield Wiper Blade Arm

(fits Case Skid Steers)

601106



Quick Attach Main Pivot Pin Kit

Case/New Holland Skid Steers

601130



Quick Attach Main Pivot Pin Kit

Case/New Holland Skid Steers: L35, L140, L150, L160, L170, L170, L175, L180, L185, L190, LS160, LS170, LS180V, LS185B, LS190B, LT190B

601134



Quick Attach Wedge Pin

Case/New Holland Skid Steers: 410, 40XT, 430, 60XT, 440, 420, 70XT

601124



JOHN DEERE



Quick Attach Main Pivot Pin

John Deere Skid Steers: 12GR, 314G, 316GR, 317G, 318G, 319D, 319E, 320D, 320E, 323D, 320E, 318E

601214



Quick Attach Main Pivot Pin Kit

John Deere Skid Steers: 326D, 326E, 328D, 328E, 329D, 329E, 332D, 332E, 333D, 333E

601230



Windshield Wiper Blade 15"

John Deere Skid Steers: 240, 260, 313, 315, 318, 325

601202



Door Spring

John Deere Skid Steers: CT315, CT322, CT332, 240, 250, 260, 270, 280, 313, 315, 317, 320, 325, 328, 332

601204



Quick Attach Main Pivot Pin Kit

John Deere Skid Steers: 240, 250, 313, 315, 317, 320

601224



Quick Coupler Complete Plate

John Deere Skid Steers: 6675, 7775, 8875 (includes lever kit and 2 bushings)

601234



Windshield Wiper Blade Arm

John Deere Skid Steers: 240, 250, 260, 270, 280, 315, 317, 320, 325,C 328, 332, CT315, CT322, CT332

601212



Key (set of 2)

John Deere Skid Steers

601200



Quick Attach Main Pivot Pin

John Deere Skid Steers: 318D, 318E, 319D, 319E, 320D, 320E, 323D, 323E

601206



Quick Attach Main Pivot Pin

John Deere Skid Steers: 326D, 326E, 328D, 328E, 329D, 329E, 332D, 332E, 333D, 333E

601218



Quick Attach Main Pivot Pin

John Deere Skid Steers: 240, 250, 313, 315, 317, 320

601216



Quick Attach Main Pivot Bushing

John Deere Skid Steers: 332D, 333D, 326D, 328E, 326E, 329E, 328D, 332E, 329D, 333E

(requires 2)

601210



Quick Attach Main Pivot Bushing

John Deere Skid Steers

601226



Cab Machines Safety Windshield

Fits models: 318D, 319D,
320D, 323D, 326D, 328D,
329D, 332D, 333D
(1/2" thick, milled edge
insert)

203251



G Cab Machines Safety Windshield

Fits models: 314G, 317G, 318G, 320G,
324G, 325G, 330G, 332G, 333G
(1/2" thick, milled edge insert)

203257



Quick Attach Latch Kit

John Deere Skid Steer

Loaders:

Electric Disconnect: 317, 320,
325, 328, 318D, 319D, 320D,
323D, 326D, 328D, 329D,
332D, 333D, CT322, 324E,
330G, 331G, 332G, 333G



Manual Disconnect: 318D, 318E, 319D, 319E, 320D, 320E, 323D,
323E, 326D, 326E, 328D, 328E, 329D, 329E, 332D, 332E, 333D,
333E

601228



Quick Attach Lever Only

John Deere Skid Steers

Left Side

601220

Right Side

601222



Fuel Cap

John Deere
Skid Steers

601208



320 and 400 Width Rubber Tracks

320 x 86 x 50 BT Block

Fits model: CT317G

603115



320 x 86 x 52 BT Block

Fits models: CT319D,
CT319E, CT322, CT323,
CT325G

603120



400 x 86 x 52

Fits model: CT319

603135



450 Width Rubber Tracks

450 x 86 x 56

Fits models: CT329,
CT330, CT333G

603150



450 x 86 x 58 BT Block

Fits models: CT331G,
CT333G

603155



Sprocket

10 Bolt x 17 Teeth

Commonly fits models: CT319,
CT323, CT329, CT331

(please verify serial number)

603325



Sprocket

8 Bolt x 16 Teeth

Commonly fits models: CT319D, CT323D

(please verify serial number)

Part Number: 603330



KUBOTA

SSV Series Safety Windshield

Fits models: SSV65, SSV75
(1/2" thick, milled edge insert)
203263



SVL Series Safety Windshield

Fits models: SVL75, SVL90, SVL95
(1/2" thick, milled edge insert)
203261



OEM PARTS



320 and 400 Width Rubber Tracks

320 x 86 x 52 BT Block
Fits models: SVL65, SVL75
603120



400 x 86 x 52
Fits model: SVL75
603135



450 Width Rubber Tracks

450 x 86 x 58 BT Block
Fits models: SVL90, SVL95
603155



Safety Mirror

Kubota Skid Steers:
SVL75 & SVL90
(includes mounting hardware)
601300



Lockable Fuel Cap
Kubota Skid Steers
601302



UNDERCARRIAGE PARTS AVAILABLE

Call 888-376-7027

for a quote!



NEW HOLLAND



Wheel Nut Set

New Holland Skid Steers: L35, L120, L125, L140, L150, L160, L170, L180, L185, L190, L225, L250, L255, L325, L425, L445, L451, L452, L454, L455, L465

601406



Wheel Stud Kit

New Holland Skid Steers: L35, L120, L125, L140, L150, L160, L170, L180, L185, L190, L225, L250, L255, L325, L425, L445, L451, L452, L454, L455, L465

601410



Fuel Cap

New Holland Skid Steers

601404



Windshield Wiper Blade Arm

New Holland 200 Series Skid Steers: L213, L215, L218, L220, L221, L223, L225, L228, L230, L234

601412



Windshield Wiper Blade Arm

New Holland Skid Steers: C175, C185, L160, L180, L190, L170, L175, C190, LS190, LT185.B, LS160, LT190.B, LS170, L185, LS180.B, LS185.B, LS190.B

601416



Windshield Dual Wiper Blade Arm

New Holland 200 Series Skid Steers (after 2013)

601418



Door Spring

New Holland Skid Steers: C175, C185, C190, L140, L150, L160, L170, L465, L565, L865, LS140, LS150, LS160, LS170, LS180, LS180B, LS185B, LS190, LS190B, LT185B, LT190B, LX465, LX485, LX565, LX665, LX865, LX885

601414



Quick Attach Wedge Pin

New Holland Skid Steers: C175, C185, C190, L140, L150, L160, L170, L175, L180, L185, L190, L465, L565, L865, LS140, LS150, LS160, LS170, LS180, LS180B, LS185B, LS190, LS190B, LT185B, LT190B, LX465, LX485, LX565, LX665, LX865, LX885, LX985

601422

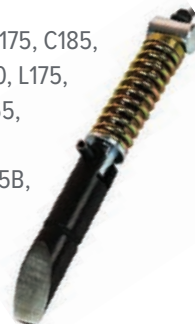

Quick Attach Main Pivot Single Bushing

Case/New Holland Skid Steers: SR130, SR150, SR175, SR200, SR220, SR250, SV185, SV250, V300, SV340, TR270, TR310, TR320, TV380, LS160, LS170, L213, L215, L218, L220, L221, L223, L225, L230, L234

Single 601122



UNDERCARRIAGE PARTS AVAILABLE

Call 888-376-7027 for a quote!



Quick Attach Lever Only

Case/New Holland Skid Steers

Left Side 601126

Right Side 601128



NEW HOLLAND



Quick Coupler Complete Plate

Case/New Holland Skid Steers: L218, L220, L223, L225, L230, C227, C232

(includes lever kit and 2 bushings)

601138



Key (set of 2)

New Holland machines

601400



Quick Attach Cylinder Pin

New Holland Skid Steers: C175, C185, C190, L140, L150, L160, L170, L175, L180, L185, L190, L465, L565, L865, LS140, LS150, LS160, LS170, LS180, LS180B, LS185B, LS190, LS190B, LT185B, LT190B, LX465, LX485, LX565, LX665, LX865, X885, LX985

601402



Quick Attach Main Pivot Pin Kit

New Holland Skid Steers: C175, C185, C190, L140, L150, L160, L170, L175, L180, L185, L190, L465, L565, L865, LS140, LS150, LS160, LS170, LS180, LS180B, LS185B, LS190, LS190B, LT185B, LT190B, LX465, LX485, LX565, LX665, LX865, LX885, LX985

601408



Quick Attach Main Pivot Pin Kit

Case/New Holland Skid Steers: L216-L230, C232-C238, SR160-SR250, SV185-SV300, TV380, TR270-TR340

601132



Quick Attach Main Pivot Pin Kit

New Holland Skid Steers: LS140, LS150, LT185.B, LS160, L865, LS170, LS180.B, L140, LS185.B, L150, L160, LX465, LX485, L170, LX565, LX665, LX865, LX885, L180, L465, SL40B, L565

601420



Quick Attach Main Pivot Pin Kit

Case/New Holland Skid Steers: L35, L140, L150, L160, L170, L170, L175, L180, L185, L190, LS160, LS170, LS180V, LS185B, LS190B, LT190B

601134



Quick Attach Main Pivot Pin Kit

Case/New Holland Skid Steers

601130



Quick Attach Wedge Pin

Case/New Holland Skid Steers: 410, 40XT, 430, 60XT, 440, 420, 70XT

601124



TAKEUCHI

Safety Windshield

Fits model: TL250
(1/2" thick, milled
edge insert)

203241



Quick Attach Wedge Pin Kit

Takeuchi Skid Steers: TL120, TL130, TL140, TL150,
TL220, TL230, TL240, TL250, TL8, TL10, TL12, TL10V2,
TL12V2, TL12R2

601504



Fuel Cap

Takeuchi Skid Steers
601502



Key (set of 2)

Takeuchi Skid Steers
601500



320 and 400 Width Rubber Tracks

320 x 86 x 50 BT Block

Fits Takeuchi: TL6

603115



400 x 86 x 49

Fits Takeuchi: TL130, TL230, TL8

603125



400 x 86 x 52

Fits Takeuchi: TL10V2

603135



400 x 86 x 52 Block

Fits Takeuchi: TL8

603140



450 Width Rubber Tracks

450 x 100 x 48

Fits Takeuchi: TL140, TL240

603160



450 x 100 x 50

Fits Takeuchi: TL150 TL250

603165



Shop online at
www.BDAparts.com



Sprocket

9 Bolt x 16 Teeth

Commonly fits Takeuchi: TL130, T8
(please verify serial number)

603335



Sprocket

9 Bolt x 15 Teeth

Commonly fits Takeuchi: TL10 V2
(not standard TL10, please verify
serial number)

603340



UNIVERSAL



Mirror with Universal Mounting Bracket

Wide style, 13" x 3.75". (fits most skid steers, includes mounting hardware)

601902



Mirror with Universal Mounting Bracket

Fat style, 8.25" x 4.75".
(fits most skid steers, includes mounting hardware)

601900



BLUE DIAMOND® ATTACHMENTS NOW ALSO OFFERS BOTTOM ROLLERS AND IDLERS FOR:

- Bobcat
- Case
- New Holland
- Caterpillar
- Gehl
- JCB
- John Deere
- Kubota
- Komatsu
- Takeuchi
- Terex
- Volvo
- Yanmar track loader
- Mini excavator models!



UNDERCARRIAGE PARTS AVAILABLE

Call 888-376-7027 for a quote!

A collection of undercarriage parts including a long track with cleats, a sprocket, a roller, and a gear.

SPROCKETS



8 Bolt x 17 Teeth
Commonly fits Bobcat: T630,
T650, T740, T870
(please verify serial number)
603310



10 Bolt x 17 Teeth
Commonly fits John Deere: CT319,
CT323, CT329, CT331
Commonly fits Newer: CT322,
CT333E, CT333G
(please verify serial number)
603325



15 Bolt x 15 Teeth
Commonly fits Bobcat: T450,
T550, T590
(please verify serial number)
603315



9 Bolt x 16 Teeth
Commonly fits Takeuchi: TL130, T8
(please verify serial number)
603335



6 Bolt x 15 Teeth
Commonly fits Bobcat: T190, T590
(please verify serial number)
603320



9 Bolt x 15 Teeth
Commonly fits Takeuchi: TL10 V2
(not standard TL10, please verify
serial number)
603340



8 Bolt x 16 Teeth
Commonly fits John Deere:
CT319D, CT323D
(please verify serial number)
603330



8 Bolt x 17 Teeth
Commonly fits Case: CT420,
CT440, CT445, CT450, TV 380,
TR270, TR310, TR320, TR340,
C175, C185, C190, LT185, LT190,
C227, C232, C238, GEHL VT320
(please verify serial number)
603345



SAFETY WINDSHIELDS

1/2" thick, milled edge insert

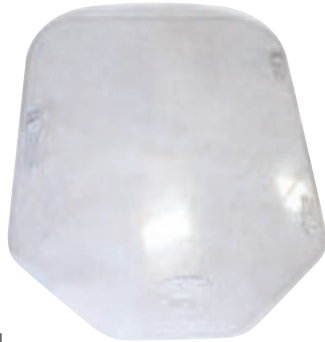

M Series Safety Windshield

Fits models: S450, S510, S530, S550, S570, S590, S630, S650, S750, S770, S850

(1/2" thick, milled edge insert)

203207



G Series Safety Windshield

Fits models: 751, 753, 763, 863, 873, 883, S130, S150, S160, S170, S185, S205, S220, S250, S300, S330, T140, T180, T190, T200, T250, T300, T320, A220, A300

(1/2" thick, milled edge insert)

203205



SSV Series Safety Windshield

Fits models: SSV65, SSV75

(1/2" thick, milled edge insert)

203263



SVL Series Safety Windshield

Fits Kubota models: SVL75, SVL90, SVL95

(1/2" thick, milled edge insert)

203261



G Cab Machines Safety Windshield

Fits models: 314G, 317G, 318G, 320G, 324G, 325G, 330G, 332G, 333G

(1/2" thick, milled edge insert)

203257



Safety Windshield

Fits model: TL250

(1/2" thick, milled edge insert)

203241



SAFETY WINDSHIELDS

1/2" thick, milled edge insert



TL Series

Fits Takeuchi model: TL250
203241



G Series

Fits Bobcat models: 751, 753, 763, 863, 873, 883, S130, S150, S160, S170, S185, S205, S220, S250, S300, S330, T140, T180, T190, T200, T250, T300, T320, A220, A300
203205



M Series

Fits Bobcat models: S450, S510, S530, S550, S570, S590, S630, S650, S750, S770, S850
203207



Cab Machines

Fits John Deere models: 318D, 319D, 320D, 323D, 326D, 328D, 329D, 332D, 333D
203251



G Cab Machines

Fits John Deere models: 314G, 317G, 318G, 320G, 324G, 325G, 330G, 332G, 333G
203256



SSV Series

Fits Kubota models: SSV65, SSV75
203263



SAFETY WINDSHIELDS

1/2" thick, milled edge insert



CAT

Fits models: C Cab Machines
203212



JCB

Fits models: 135, 150, 175, 190, 205, 210, 215, 225, 250,
260, 270, 280, 300, 320, 3TS-8T, 3TS-8W
203271



CAT

Fits models: D Cab Machines
203214



Terex

Fits models: ASV-TR75, VT70
203281



Terex

Fits models: PT75, PT80
203283



Gehl

Fits model: RT250
203247



Positrack

Fits models: ASV-RC85 & RC100
203266



STORAGE SYSTEMS & DISPLAY SOLUTIONS

Great for showrooms, trade shows, and training!



Universal Stand
700006



Auger Bit Holder
105950



Hydraulic Breaker Holder
Holds up to 6 units (size HB50–HB300).
135900



Brush Cutter Display Stand
700005
700005-SDKIT required for Severe Duty model



Hydraulic Breaker Stand
700020



PARTS & ACCESSORIES



888-376-7027



BDAParts.com

© 2023 Blue Diamond® Attachments. All rights reserved.